

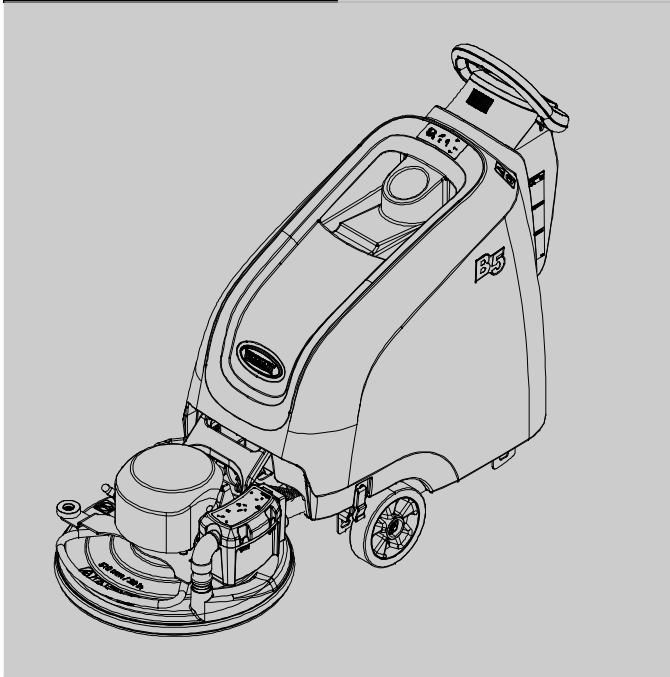

B5/B7

Walk-Behind Battery Burnisher

English **EN**
Operator Manual



TennantTrue[®] Parts

North America / International



For the latest Parts manuals and other language Operator manuals, visit:

www.tennantco.com/manuals

www.tennantco.com

9011480
Rev. 04 (03-2020)



INTRODUCTION

This manual is furnished with each new model. It provides necessary operation and maintenance instructions.



Read this manual completely and understand the machine before operating or servicing it.

A complete illustrated Parts Manual is also furnished with each new model. Use the Parts Manual to order replacement parts. To ensure prompt delivery, follow the "HOW TO ORDER PARTS" instructions printed in the Parts Manual.

This machine will provide excellent service. However, the best results will be obtained at minimum costs if:

- The machine is operated with reasonable care.
- The machine is maintained regularly - per the maintenance instructions provided.
- The machine is maintained with manufacturer supplied or equivalent parts.

To view, print or download manuals online visit www.tennantco.com/manuals



PROTECT THE ENVIRONMENT

Please dispose of packaging materials and used machine components such as batteries in an environmentally safe way according to your local waste disposal regulations.



Always remember to recycle.

INTENDED USE

The burnisher machine is intended for commercial use, for example in hotels, schools, hospitals, factories, shops, offices and rental businesses. It is designed to burnish smooth dry hard floor surfaces (VCT, terrazzo, marble, finished hardwood, coated concrete, etc.) in an indoor environment only. Do not use this machine on carpeted surfaces. Use only recommended burnishing pads intended for machine application. Do not use this machine other than described in this Operator Manual.

MACHINE DATA

IMPORTANT: To ensure full warranty protection, fill out the attached MACHINE INSTALLATION / WARRANTY REPORT REPLY CARD and return to Tennant within 30 days of purchase.

Please fill out at time of installation for future reference.

Model No. - _____

Serial No. - _____

Installation Date - _____

Tennant Company

PO Box 1452

Minneapolis, MN 55440

Phone: (800) 553- 8033

www.tennantco.com

"Set and Forget" is a trademark of Tennant Company.

Trojan and HydroLINK are registered trademarks of Trojan Battery Company.

Specifications and parts are subject to change without notice.

Original Instructions. Copyright ©2014- 2020 Tennant Company. All rights reserved. Printed in U.S.A.

TABLE OF CONTENTS

INTRODUCTION	2	MAINTENANCE	
INTENDED USE	2	MAINTENANCE CHART	18
MACHINE DATA	2	MACHINE MAINTENANCE	19
 		AFTER DAILY USE	19
OPERATION		AFTER WEEKLY USE	19
IMPORTANT SAFETY INSTRUCTIONS	4	AFTER EVERY 50 HOURS OF USE	20
SAFETY LABELS	6	AFTER EVERY 100 HOURS OF USE	20
MACHINE COMPONENTS	7	AFTER EVERY 200 HOURS OF USE	20
MACHINE INSTALLATION	8	AFTER EVERY 1000 HOURS OF USE	21
UNCRATING MACHINE	8	MOTOR MAINTENANCE	21
INSTALLING BATTERIES	8	BATTERIES	21
HOW THE MACHINE WORKS	9	MAINTENANCE-FREE BATTERIES	21
MACHINE SETUP	9	FLOODED (WET) LEAD-ACID BATTERIES	21
INSTALLING BURNISHING PAD	9	CHECKING CONNECTIONS / CLEANING ..	22
PAD PRESSURE SETTING (Models equipped with		CHARGING BATTERIES	22
mechanical pad pressure adjustment)	10	BATTERY CHARGER SETTINGS	23
INSTALLING DUST COLLECTION BAG		HYDROLINK® BATTERY WATERING	
AND HEPA FILTER	11	SYSTEM (OPTION)	25
MACHINE OPERATION	12	MACHINE JACKING	26
PRE-OPERATION	12	LOADING/UNLOADING MACHINE FOR	
OPERATING THE MACHINE	12	TRANSPORTING	26
EMERGENCY SHUT-OFF BUTTON		STORING MACHINE	27
(Drive Models)	14	TROUBLESHOOTING	28
CONTROL CONSOLE ALERT SYMBOLS ..	14	 	
WHILE OPERATING THE MACHINE	14	SPECIFICATIONS	
BATTERY DISCHARGE INDICATOR	15	B5 GENERAL MACHINE DIMENSIONS/	
HOUR METER	15	CAPACITIES/PERFORMANCE	29
CIRCUIT BREAKERS / FUSE	15	B7 GENERAL MACHINE DIMENSIONS/	
SERVICE INDICATOR CODES	16	CAPACITIES/PERFORMANCE	30
		B5 MACHINE DIMENSIONS	31
		B7 MACHINE DIMENSIONS	32

IMPORTANT SAFETY INSTRUCTIONS - SAVE THESE INSTRUCTIONS

The following warning precautions are used throughout this manual as indicated in their description:

⚠ WARNING: To warn of hazards or unsafe practices which could result in severe personal injury or death.

FOR SAFETY: To identify actions which must be followed for safe operation of equipment.

The following information signals potentially dangerous conditions to the operator. Know when these conditions can exist. Locate all safety devices on the machine. Report machine damage or faulty operation immediately.

⚠ WARNING: To Reduce the Risk of Fire, Explosion, Electric Shock or Injury:

- Read manual before operating machine.
- Do not use or pick up flammable materials.
- Do not use near flammable liquids, vapors or combustible dusts.
This machine is not equipped with an explosion proof motor. The electric motor will spark upon start up and during operation which could cause a flash fire or explosion if machine is used in an area where flammable vapors/liquids or combustible dusts are present.
- Batteries emit hydrogen gas. Explosion or fire can result. Keep sparks and open flame away when charging.
- Disconnect battery cables and charger cord before cleaning and servicing machine.
- Do not charge batteries with damaged cord. Do not modify plug.
If the charger supply cord is damaged or broken, it must be replaced by the manufacturer or its service agent or a similarly qualified person in order to avoid a hazard.
The use of incompatible battery chargers may damage the battery and potentially cause a fire hazard.
- Do not use outdoors or on wet surfaces. Store indoors. This machine is for dry use only.
- This machine is not suitable for picking up hazardous dust.
- Spinning pad, keep hands away.

FOR SAFETY:

1. Do not operate machine:
 - Unless trained and authorized.
 - Unless operator manual is read and understood.
 - Unless mentally and physically capable of following machine instructions.
 - Under the influence of alcohol or drugs.
 - While using a cell phone or other types of electronic devices.
 - If not in proper operating condition.
 - In outdoor areas. This machine is for indoor use only.
 - With pads or accessories not supplied or approved by Tennant. The use of other pads may impair safety.
 - In areas with possible falling objects.
 - In areas that are too dark to safely see the controls or operate machine.
 - Without dust bag and filters in place.
2. Before operating machine:
 - Make sure all safety devices are in place and operate properly.
3. When operating machine:
 - Use only as described in this manual.
 - Report machine damage or faulty operation immediately.
 - Wear closed-toe, non-slip work shoes.
 - Reduce speed when turning.
 - Keep hands away from spinning pad.
 - Go slowly on inclines and slippery surfaces.
 - Do not burnish on inclines that exceed 9% grade or transport on inclines that exceed 19.5% grade.
 - Do not carry passengers on machine.
 - Use care when reversing machine.
 - Keep children and unauthorized persons away from machine.
 - Do not allow to be used as a toy.

4. **Before leaving or servicing machine:**
 - Stop on level surface.
 - Set the parking brake, if equipped.
 - Turn off machine and remove key.
5. **When servicing machine:**
 - Disconnect battery connection and charger cord before working on machine.
 - All work must be done with sufficient lighting and visibility.
 - All repairs must be performed by trained personnel.
 - Use Tennant supplied or approved replacement parts.
 - Do not modify the machine from its original design.
 - Avoid moving parts. Do not wear loose clothing or jewelry and secure long hair.
 - Do not disconnect the off-board charger's DC cord from the machine's receptacle when the charger is operating. Arcing may result. If the charger must be interrupted during charging, disconnect the AC power supply cord first.
 - Do not use incompatible battery chargers as this may damage battery packs and potentially cause a fire hazard.
 - Inspect charger cord regularly for damage.
 - Keep work area well ventilated.
 - Avoid contact with battery acid.
 - Keep all metal objects off batteries.
 - Do not power spray or hose off machine.
 - Use a hoist or adequate assistance when lifting batteries.
 - Jack machine up at designated locations only. Support machine with jack stands.
 - Block machine tires before jacking machine up.
 - Use a hoist or jack that will support the weight of the machine.
 - Wear personal protection equipment as needed and where recommended in this manual.
6. **When loading/unloading machine onto/off truck or trailer:**
 - Use a ramp that can support the machine weight and operator.
 - Do not operate the machine on a ramp incline that exceeds a 19.5% grade level.
 - Use a winch if ramp incline exceeds a 19.5% grade level.
 - Lower the pad driver after loading.
 - Turn machine off and remove key.
 - Set parking brake (if equipped).
 - Block machine wheels.
 - Use tie-down straps to secure machine.



For Safety: wear protective gloves.



For Safety: wear eye protection.



For Safety: wear protective dust mask.

OPERATION

SAFETY LABELS

The safety labels appear on the machine in the locations indicated. Replace labels if they are missing or become damaged or illegible.

WARNING LABEL - Located on side of control console.

⚠ WARNING



TO REDUCE THE RISK OF FIRE, EXPLOSION, ELECTRICAL SHOCK, OR INJURY:

- Read manual before operating machine.
- Do not use or pick up flammable materials.
- Do not use near flammable liquids, vapors or combustible dusts.
- Batteries emit hydrogen gas. Explosion or fire can result. Keep sparks and open flame away when charging.
- Disconnect battery cables and charger cord before servicing.
- Do not charge batteries with damaged cord. Do not modify plug.
- Do not use outdoors or on wet surfaces. Store indoors.

⚠ AVERTISSEMENT

POUR REDUIRE LES RISQUES D'INCENDIE, L'EXPLOSION, DE CHOC ELECTRIQUE OU DE BLESSURE:

- Lisez le manuel avant d'utiliser la machine.
- N'utilisez pas ou ne ramassez pas de matériaux inflammables.
- N'utilisez pas près de liquides, vapeurs ou poussières inflammables.
- Les batteries émettent du gaz hydrogène. Risque d'incendie et d'explosion. Évitez toute étincelle et toute flamme nue à proximité des batteries.
- Débranchez les câbles de batterie et le cordon du chargeur avant l'entretien.
- Ne chargez pas la batterie avec un cordon endommagé. Ne modifiez pas la prise.
- Ne pas utiliser en extérieur ou sur des surfaces humides. Ranger à l'intérieur.

⚠ ADVERTENCIA

PARA REDUCIR EL RIESGO DE INCENDIO, EXPLOSION, CHOQUE ELECTRICO, O LESIONES:

- Lea el manual antes de operar la máquina.
- No utilice ni recoja materiales inflamables.
- No utilice la máquina cerca de líquidos, polvos o vapores inflamables.
- Las baterías emiten hidrógeno gaseoso. Peligro de incendio o explosión. Mantenga chispas y llamas alejadas de la máquina.
- Desconecte los cables de la batería y del cargador antes de realizar operaciones de mantenimiento en la máquina.
- No cargue las baterías si el cable está dañado. No modifique el enchufe.
- No lo utilice en exteriores ni en superficies húmedas. No guarde el aparato a la intemperie.

1206004



⚠ WARNING



Spinning Pad.
Keep Hands Away.

⚠ AVERTISSEMENT

Patin En Rotation.
Éloignez Vos Mains.

⚠ ADVERTENCIA

Almohadilla Giratoria.
Mantenga Alejadas Las Manos.

1206788

WARNING LABEL - Spinning Pad. Keep Hands Away.

Located on burnishing head.





1204364

WARNING LABEL - Disconnect battery cables before servicing machine.

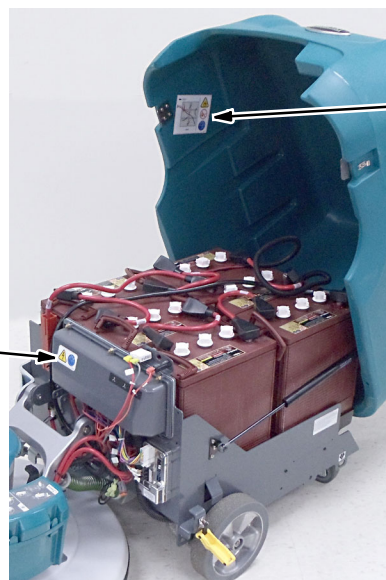
Located on control board cover.









WARNING LABEL - Batteries emit hydrogen gas. Explosion or fire can result. Keep sparks and open flame away when charging.

Located on backside of machine cover.

MACHINE COMPONENTS

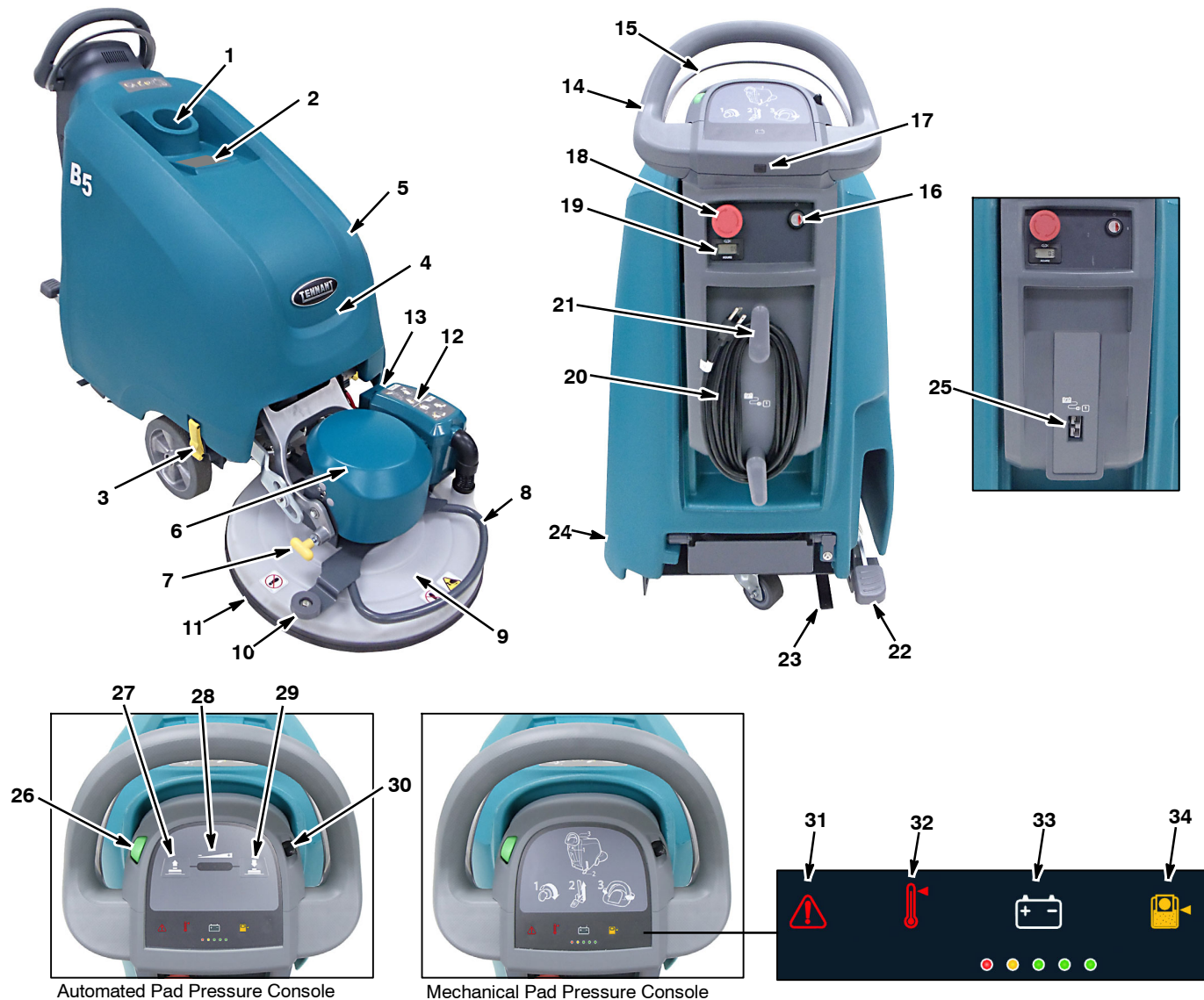

- | | |
|--|--|
| <ul style="list-style-type: none"> 1. Cup Holder 2. On- board Instruction Guide 3. Battery Compartment Hood Latches 4. Circuit Breaker Panel, located near batteries. 5. Battery Compartment Hood 6. Burnishing Pad Motor 7. Head Tilt Lock/Release Knob 8. Bumper/Head Lift Handle 9. Burnishing Head 10. Wall Roller 11. Dust Control Skirt 12. Dust Collection Bag Compartment 13. HEPA Filter (Active Dust Collection Model) 14. Control Handle 15. Start Bail 16. Main Power On/Off Key Switch 17. USB Program Port 18. Emergency Stop Button (Drive Model) | <ul style="list-style-type: none"> 19. Hour Meter 20. On- board Battery Charger Cord 21. On- board Battery Charger Cord Storage Hooks 22. Burnishing Head Lift Pedal 23. Anti- static Strap 24. Parking Brake (Optional) 25. Off- board Battery Charger Receptacle 26. Speed Dial (Drive Model) 27. Pad Pressure Decrease Button (Automated Model) 28. Pad Pressure Indicator (Automatic Model) 29. Pad Pressure Increase Button (Automated Model) 30. Directional Lever (Drive Model) 31. Service Indicator 32. Motor Overheat Indicator 33. Battery Discharge Indicator 34. Check Dust Bag Indicator |
|--|--|

MACHINE INSTALLATION

UNCRATING MACHINE

1. Carefully check machine for signs of damage. Report damages at once to carrier.
2. Check the contents list. Contact distributor or Tennant for missing items.
Contents:
 - Burnishing Pad (pre-installed)
 - Dust Collection Bag (pre-installed)
Cloth bag (Option)
 - Battery Tray
 - Battery Watering System (pre-installed Option)
 - Off-Board Battery Charger (Option)
 - Charger Cord/off-board charger model (Option)
 - Parts Manual
 - Use & Care Guide Wall Chart20 in / 510mm Model:
 - 3 Batteries (pre-installed Option)
 - 2 Battery Cables
 - 6 Battery Post Rubber Boots
 - 1-2 Foam Battery Spacers24 in/610mm, 27 in/690mm Models:
 - 6 Batteries (pre-installed Option)
 - 5 Battery Cables
 - 12 Battery Post Rubber Boots
 - 2 Foam Battery Spacers (AGM Batteries)
3. To uncrate the machine, remove straps, wheel blocks and shipping brackets. Using the supplied ramp carefully back the machine off the pallet (Figure 1). Make sure the burnishing head is in the raised position.

ATTENTION: Do not remove machine from pallet without using ramp, machine damage may occur.



FIG. 1

INSTALLING BATTERIES

Contact distributor or Tennant for battery recommendations if machine is not supplied with batteries.

IMPORTANT: For machine's supplied with batteries and battery charger, the battery discharge indicator is factory programmed for battery type supplied. For machine's supplied without batteries, the machine's battery discharge indicator (BDI) is pre-programmed to work with wet/lead acid batteries as the default. If installing a different battery type (i.e. sealed, AGM batteries, etc.) the battery discharge indicator will need to be reprogrammed to prevent battery damage. See BATTERIES for further details.

BATTERY SPECIFICATIONS:

B5 Model -

3- 12 volt, deep cycle, 185 AH wet lead acid batteries (Push Model).

3- 12 volt, deep cycle, 225 AH wet lead acid batteries (Drive Model).

3- 12 volt, deep cycle, 234 AH AGM sealed batteries (Optional, Push and Drive Models)

B7 Model -

6- 6 volt, deep cycle, 240 AH wet lead acid batteries (24 in/610mm Model).

6- 6 volt, deep cycle, 330 AH wet lead acid batteries (27 in/690mm Models).

6- 6 volt, deep cycle, 360 AH wet lead acid batteries (Optional, 24 in/610mm, 27 in/690mm Models).

6 - 6 volt, deep cycle, 312 AH AGM sealed batteries (Optional, 24 in/610mm, 27 in/690mm Models)

⚠ WARNING: Fire Or Explosion Hazard. Batteries emit hydrogen gas. Explosion or fire can result. Keep sparks and open flame away when charging.

FOR SAFETY: When servicing machine, wear appropriate personal protection equipment as needed. Avoid contact with battery acid.

1. Park the machine on a level surface, turn machine off and remove the key.
2. Unlatch the battery compartment hood latches and lift the hood backwards (Figure 2).
3. With adequate assistance carefully install the batteries into the battery compartment. Arrange the batteries as shown (Figure 3).

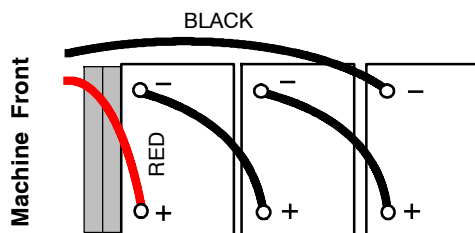

FIG. 2

FOR SAFETY: When servicing machine, use a hoist or adequate assistance when lifting batteries.

4. To keep the batteries from moving, position the supplied foam battery spacers as shown (Figure 3).
5. Using the supplied battery post boots, connect the cables to the battery posts as shown (Figure 3). Connect the machine's black (-) battery cable last. Use insulated tools when working near batteries.

B5 Model



Foam Spacers:
 1 - Wet Batteries
 2 - AGM Batteries

B7 Model

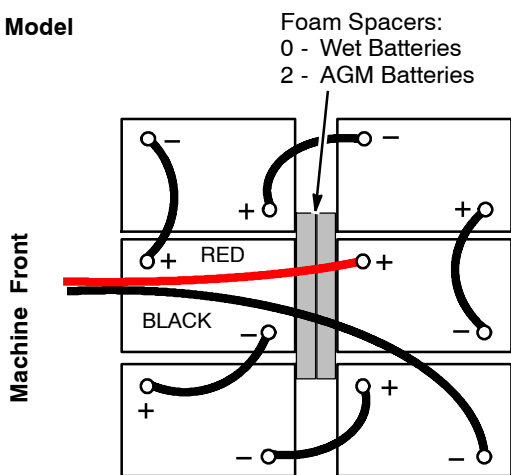

Foam Spacers:
 0 - Wet Batteries
 2 - AGM Batteries

FIG. 3

HOW THE MACHINE WORKS

The machine is powered by a 36V battery pack (Wet lead/acid or sealed/AGM batteries). The burnishing process is accomplished by a high-speed rotating pad with applied pressure and forward motion creating a smooth polished floor finish. The push model is assisted by the rotating pad and the drive model is equipped with a propel motor. The pad pressure and burnishing speed can be adjusted for floor type and floor condition. Depending on model, the pad pressure is mechanically adjusted or done by an actuator. The dust is collected with a passive or active dust control vacuum system. The passive dust control vacuum system uses centrifugal force from the rotating pad to create a vacuum for dust collection. The active dust control vacuum system model consists of a vacuum motor and a high efficiency HEPA rated filter. The burnishing function is controlled by a start bail at the control console.

MACHINE SETUP

INSTALLING BURNISHING PAD

There are many types of burnishing pads to choose from depending on floor type, finish and floor condition. Contact an authorized distributor for burnishing pad recommendations.

Each new machine comes equipped with one pre-installed burnishing pad.

- Replacement Factory Supplied Burnishing Pads:
- 611788 - 20 in/510mm Hair Blend Burnishing Pad (Qty. 5)
 - 1204254 - 24 in/610mm Hair Blend Burnishing Pad (Qty. 1)
 - 1204255 - 27 in/690mm Hair Blend Burnishing Pad (Qty. 1)

FOR SAFETY: Do not operate machine with pads or accessories not supplied or approved by Tennant. The use of other pads may impair safety.

1. Park the machine on a level surface, turn machine off and remove the key.

OPERATION

2. Step down and to the left on the burnishing head lift pedal to raise head off floor (Figure 4). Pull the head lift handle upward until head locks into the pad change position.



FIG. 4

3. Install the burnishing pad on pad driver (Figure 5). Make sure pad is centered on pad driver. Secure pad with center-lock. Do not operate machine without pad center-lock installed.



FIG. 5

4. Pull the head tilt lock knob to release the head from the pad change position (Figure 6).



FIG. 6

PAD PRESSURE SETTING (Models equipped with mechanical pad pressure adjustment)

For models equipped with mechanical pad pressure adjustment, the pad pressure is factory set at the optimal setting. Many variables come in to play to achieving optimal burnishing performance; floor type, floor finish, floor condition and pad type.

To confirm that the factory setting best meets your burnishing application, it's recommended to perform the following procedure. Once the pad pressure is properly set for your burnishing application, this will provide consistent performance for your routine burnishing schedule. This is referred to as the "Set and Forget" method.

1. To activate the pad pressure mode, locate the hidden button (small indent) on the left side of the control panel (Figure 7).
2. Press and hold the hidden button and turn the key on. Hold the button until a single green light appears at the battery discharge indicator (Figure 7). When the button is released, the green light will turn off and the service indicator symbol will turn on.

The machine is now ready to verify the current pad pressure.



FIG. 7

3. Pull the start bail and begin burnishing for a minimum of 10 seconds (Figure 8). The LED's will ripple then a single light will appear confirming the current pad pressure setting. See the following chart for down pressure settings.



FIG. 8

LED Code	*=On	Down Pressure Setting
*		Flashing - Too Low
*		Low
. * . . .		Medium Low
. . * . .		Medium
. . . * .		Medium High
. . . . *		High
. . . . *		Flashing - Too High

The medium down pressure setting is recommended. Determine the burnishing performance at this setting and adjust as necessary.

To adjust pressure setting proceed to the next step.

4. Raise the burnishing head and remove key. Locate the pad pressure adjustment cotter pin (Figure 9).

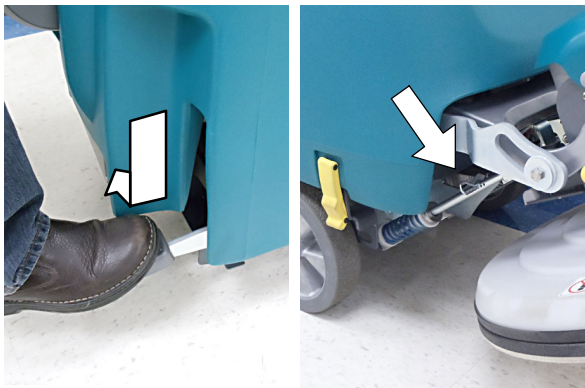

FIG. 9

5. To increase down pressure, move the cotter pin to the next hole towards the motor. To decrease the down pressure move the cotter pin in opposite direction (Figure 10).



FIG. 10

6. Repeat steps 1-3 and adjust the pin until desired down pressure is achieved.

INSTALLING DUST COLLECTION BAG AND HEPA FILTER

Each new machine is equipped with one pre-installed paper bag. Models equipped with the optional Active Dust Control system includes a pre-installed HEPA filter.

Replacement bags/filters:
 p/n 1210869 - 1 package/10 paper bags
 p/n 1208744 - Cloth bag (optional).
 p/n 1203162 - HEPA filter

NOTE: The optional cloth bag is not intended for models equipped with the Active Dust Control system.

FOR SAFETY: Do not operate machine without dust bag and filters in place.

1. Park the machine on a level surface, turn machine off and remove the key.
2. Remove the the cover from the dust collection bag compartment. Press the two cover tabs to remove cover (Figure 11).

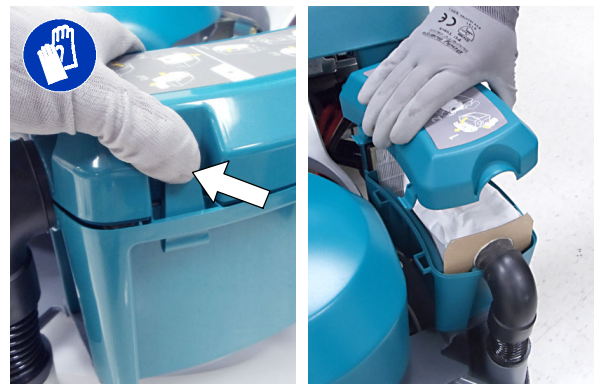

FIG. 11

3. Install dust bag and HEPA filter as shown. Replace cover (Figure 12). The HEPA filter is included with the Active Dust Collection model.

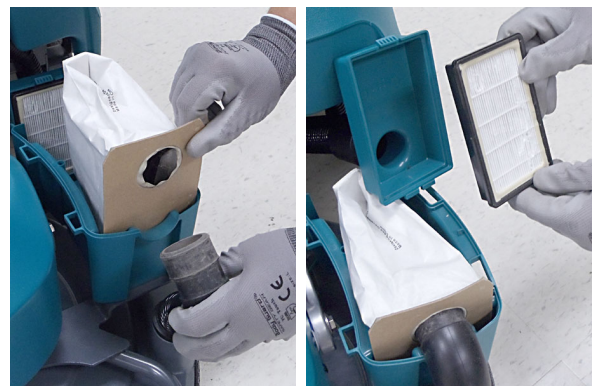

FIG. 12

OPERATION

- The check dust bag indicator will periodically light up on the control console alerting operator to check bag for fullness. Replace the bag when it becomes half full (Figure 13). Restart the key to reset the check bag indicator.

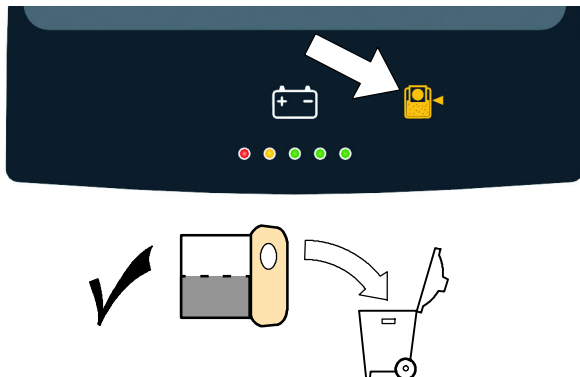

FIG. 13

- The HEPA filter requires to be replaced every 200 hours of use (Figure 14).



FIG. 14

MACHINE OPERATION

FOR SAFETY: Do not operate machine unless operator manual is read and understood.

PRE- OPERATION

- Sweep floor and remove any obstructions.
- Scrub floor from any soil buildup.
- Check that the floor surface is dry.
Do not use machine with spray buffing solution.
- Check battery discharge level indicator.
- Select proper burnishing pad.
- Check condition of burnishing pad.
- Check dust collection bag for fullness.
- Check vacuum hose connection at bag compartment.
- Check machine for proper operation.

OPERATING THE MACHINE

- Lower the burnishing head to the floor by releasing the burnishing head lift pedal as shown (Figure 15).



FIG. 15

- Release the parking brake lever if equipped (Figure 16)
- Turn the key to the on (I) position (Figure 16).

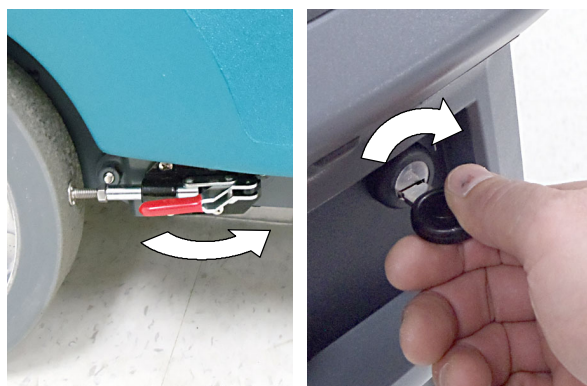

FIG. 16

- For drive models, push the directional lever to the forward position (Figure 17). To reverse machine pull the directional lever backwards.



FIG. 17

- To begin burnishing, pull the start bail (Figure 18). The burnishing head will draw to the floor by suction.



FIG. 18

- For push models, slowly push the machine forward. The rotating brush will help assist the machine forward.

For drive models, adjust the burnishing speed by turning the speed dial to the desired speed (Figure 19).



FIG. 19

- For models equipped with automated down pressure, adjust the pad pressure to the desired setting by pressing the increase or decrease pad pressure buttons (Figure 20). For optimal performance set the pad pressure indicator to the center LED setting.

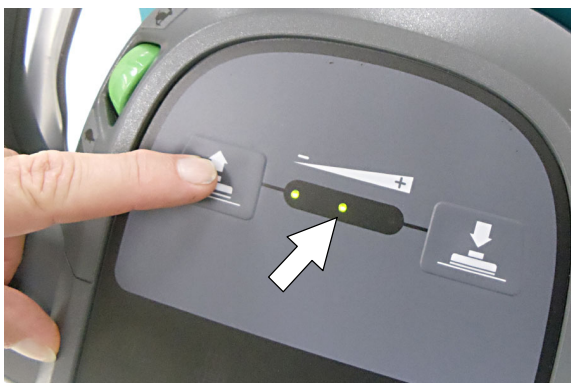

FIG. 20

For models equipped with mechanical pad pressure, the pad pressure setting is factory set for optimal performance. To confirm the pad pressure is properly set for your burnishing application, see PAD PRESSURE SETTING in the MACHINE SETUP section.

- To stop burnishing, release the start bail (Figure 21). The drive model has an electromagnetic brake system that will automatically stop the machine when the bail is released.



FIG. 21

- To transport the machine from one location to another, raise the burnishing head to the transport position (Figure 22).



FIG. 22

OPERATION

EMERGENCY SHUT-OFF BUTTON (Drive Models)

Push the emergency shut-off button in the event of an emergency (Figure 23). This red button shuts off all power to machine. To regain power, turn the button clockwise and restart the key.

Only use this button in the event of an emergency. It is not intended for routine machine shutdown.

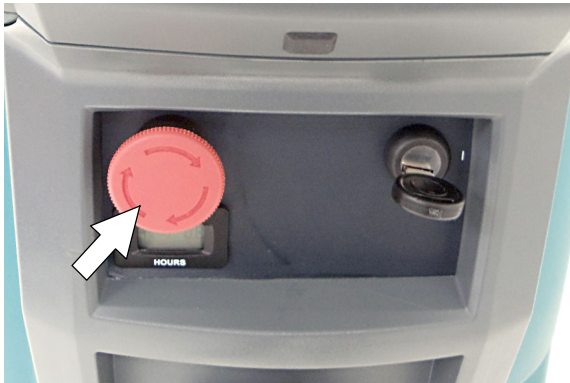
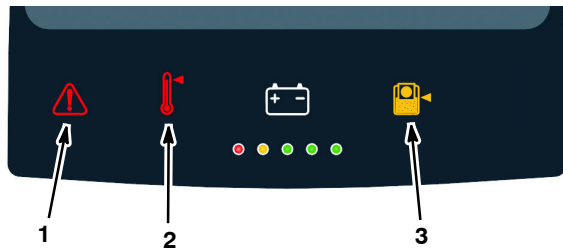

FIG. 23

CONTROL CONSOLE ALERT SYMBOLS

The following control console alert symbols will light up and begin to flash as described below.



1 - Service Indicator - Machine or battery charger fault detected. See **SERVICE INDICATOR CODES**.

2 - Pad Motor Overheat Indicator - Motor temperature is too high. Turn machine off and allow pad motor to cool down. The fault will clear once motor has cooled. Likely cause, pad pressure is set too high or wrong pad type. Reduce pad pressure or change pad type.

3 - Check Dust Bag Indicator - Reminder to check dust bag for fullness. Replace bag when half full. Recycle key to reset indicator.

WHILE OPERATING THE MACHINE

1. Operate the machine in a straight path where possible and overlap the burnishing path by a few inches/centimeters.
2. Reduce the machine speed when making sharp turns.
3. Do not use machine with spray buffing solution.
4. Avoid any floor fixtures or uneven floor transitions that may damage the pad, pad driver or dust skirt.
5. Avoid bumping the machine into posts and walls.
6. Do not operate machine on inclines that exceed a 9% grade or a 19.5% grade when transporting.
7. Drive Models: For heavily scuffed floors reduce the speed and increase the pad pressure to ensure optimum burnishing performance.
8. Periodically check the pad condition. If loaded with floor finish or soil buildup turn the pad over or replace pad as needed.
9. Check dust bag when the check bag indicator appears. Replace bag when half full.
10. Check condition of dust control skirt. Dry chunks of floor finish may become lodged in skirt leaving streaks on floor.
11. Observe the battery charge level indicator. See **BATTERY CHARGE LEVEL INDICATOR**.
12. If the drive model becomes disabled, it can be pushed or towed slowly for a short period.
13. When leaving machine unattended, turn machine off and remove key.
14. After burnishing, perform the machine maintenance procedures. See **MACHINE MAINTENANCE**.

BATTERY DISCHARGE INDICATOR

The battery discharge indicator (BDI) displays the charge level of the batteries. When the batteries are fully charged, all five indicator lights will be on (Figure 24). As the batteries discharge, the indicator lights will begin to go out from right to left.

When the discharge level reaches the red light, stop burnishing and recharge the batteries. If the red light begins to flash, the burnishing function will automatically shut off to protect the batteries from total discharge. Drive Model: The machine will still propel when red light is flashing. Propel machine to charging station and recharge batteries.

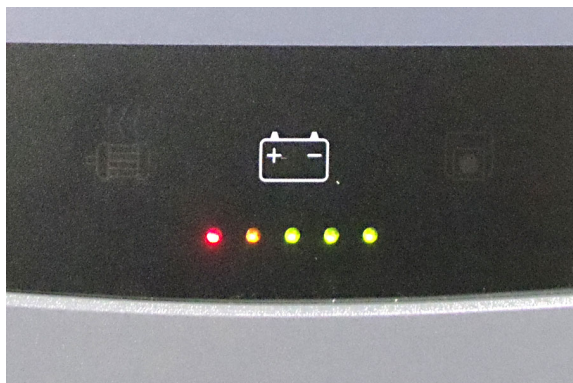

FIG. 24

The machine's battery discharge indicator is programmed for the battery type supplied with your machine. If you choose to change to a different battery type or battery capacity (i.e. wet/lead acid, sealed, AGM batteries, etc.) you will need to have the BDI reprogrammed to prevent battery damage. See *BATTERIES*.

HOUR METER

The hour meter records the number of hours the machine is in operation. Use the hour meter to perform specific maintenance procedures and to record service history. The hour meter is located on the control console (Figure 25).



FIG. 25

CIRCUIT BREAKERS / FUSE

The machine is equipped with three resettable circuit breakers to protect the machine from a current overload. If a breaker should trip, determine the cause then reset the circuit breaker. If circuit breaker does not reset or continues to trip contact trained personnel.

The circuit breakers are located near the battery compartment and identified as described below (Figure 26).

CIRCUIT BREAKERS:

- 1 (2.5A) Control Board
- 2 (15A) Actuator/Active Dust Control
- 3 (30A) Main/Propel/Pad Drive

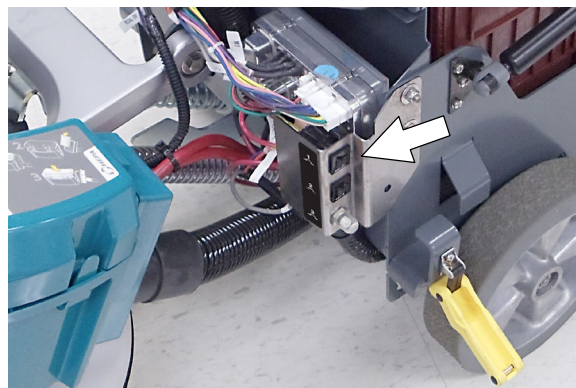

FIG. 26

FOR SAFETY: When servicing machine, all repairs must be performed by trained personnel.

OPERATION

SERVICE INDICATOR CODES

When the machine or battery charger detects a fault or warning, the red service indicator and a specific battery discharge indicator LED code will flash continuously. Refer to following LED codes to determine fault.

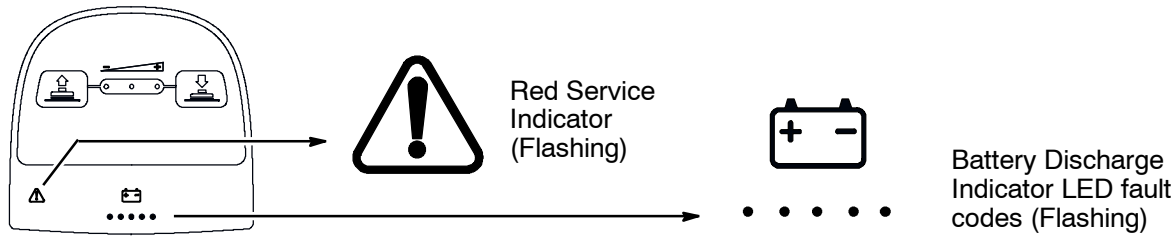

LED Fault Codes: * = Flashing	CAUSE	SOLUTION
* * * * *	Emergency stop button activated.	Turn emergency stop button counter-clockwise to reset and restart machine.
. . . * *	Pad motor wiring, connector or control board problem.	Contact service.
*	Pad motor voltage loss.	Contact service.
* . . * *	Pad motor current is above hardware limit.	Restart machine. If fault code persists, contact service.
* . * . .	Pad motor current too high for extended period. Pad down pressure too high.	Reduce down pressure. If fault code persists, contact service.
* * * . *	Pad motor shorted current load.	Contact service.
* . * * .	Pad motor and control board problem.	Contact service.
. . . * .	Head actuator wiring, connector or control board problem.	Contact service.
. * . . *	Burnish over current.	Contact service.
. . * . *	Head actuator circuit breaker tripped.	Turn machine off and reset circuit breaker. If breaker trip repeats, contact service.
* * . * *	Head actuator movement is obstructed.	Restart machine to clear code. If fault code persists, contact service.
* * * * .	Head actuator or vacuum motor and control board problem.	Contact service.
. . * . .	Vacuum motor wiring, connector or control board problem	Contact service.
. . * . *	Vacuum motor circuit breaker tripped.	Turn machine off and reset circuit breaker. If breaker trip repeats, contact service.
* . * * *	Vacuum motor current is above hardware limit.	Restart machine. If fault code persists, contact service.
* * . . .	Vacuum motor current too high for extended period (current 1 fault).	Restart machine. If fault code persists, contact service.
* * . . *	Vacuum motor current too high for extended period (current 2 fault).	Restart machine. If fault code persists, contact service.
* * . * .	Vacuum motor shorted current load.	Contact service.
* . . . *	Propel control board communication problem.	Contact service.
. . * * *	Propel wiring, connector or control board problem.	Contact service.
* . * . *	Start bail is pulled before turning machine on.	Release start bail before turning machine on.

SERVICE INDICATOR CODES - Continued

LED Fault Code: * = Flashing	CAUSE	SOLUTION
* • • * •	Propel motor short.	Contact service.
• • * * •	Propel circuit breaker tripped.	Turn machine off and reset circuit breaker. If breaker trip repeats, contact service.
• * • * *	Software load failure.	Contact service.

On-Board Battery Charger Service Indicator codes:

LED Fault Code: * = Flashing	CAUSE	SOLUTION
* * * • •	Charger error condition.	Contact service.
• * * • •	Charger is not connected to battery pack.	Check cable connections.
• * • • •	Charger overheated.	Let charger cool. Move to well ventilated area. Charge batteries in areas with temperatures 80°F/27°C or less. If fault persists, contact service.
• * * * •	Charger not communicating with machine.	Restart charger. If fault code persists, contact service.
• * * • *	Charger timer exceeded maximum charging time. Interrupts charging cycle.	Replace Batteries.

MAINTENANCE

MAINTENANCE CHART

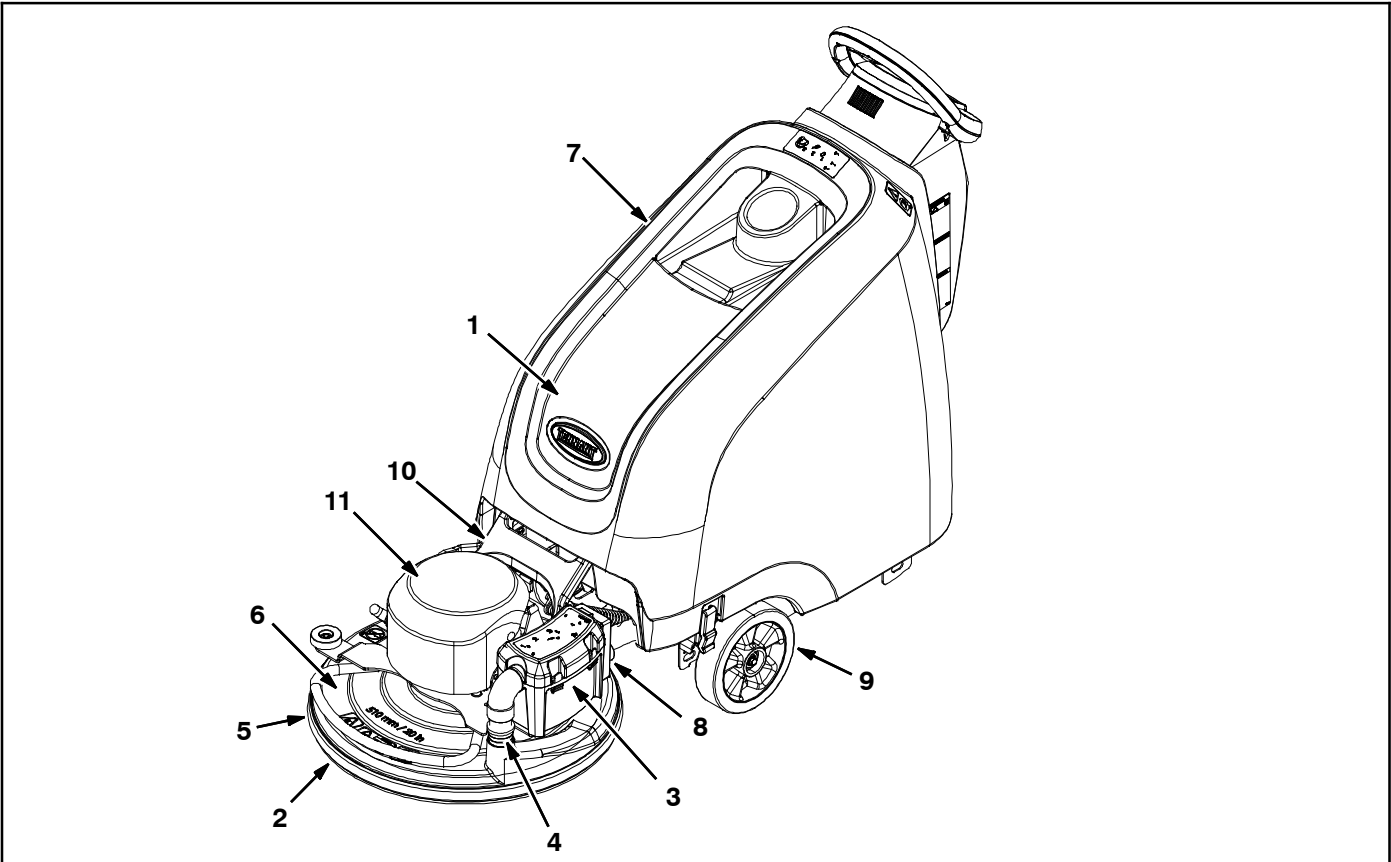

Interval/ Hours	Person Resp.	Key	Description	Procedure
Daily	O	1	Batteries	Charge
	O	2	Burnishing pad	Check, flip or replace
	O	3	Dust collection bag	Check, replace
	O	4	Vacuum hose	Check, clean
	O	5	Burnishing head dust skirt	Check for dry floor finish chunks
Weekly	O	1	Battery electrolyte level	Check, add distilled water if low
50 Hours	O	5	Burnishing head dust skirt	Check for wear and damage
	O	6	Burnishing head	Clean with air pressure hose
	O	7	Machine	Clean with damp cloth
100 Hours	O	1	HydroLINK Battery watering system (option)	Check hoses and connections for damage and wear
200 Hours	O	1	Batteries, terminals and cables	Check and clean
	O	8	Vacuum HEPA filter (Active Dust Control Model)	Check, clean, replace
750 Hours	T	9	Propel motor (Drive Model)	Replace carbon brushes
1000 Hours	T	10	Head lift bushings, 4 points	Inspect, replace bushings
	T	11	Pad motor	Replace carbon brushes

O = Operator T = Trained Personnel

MACHINE MAINTENANCE

To keep the machine in good working condition, simply perform the following maintenance procedures.

FOR SAFETY: Before leaving or servicing machine, stop on level surface, turn off machine, remove key and set parking brake if equipped.

FOR SAFETY: When servicing machine wear personal protection equipment as needed. All repairs must be performed by trained personnel

AFTER DAILY USE

1. Flip the burnishing pad over or change to a new pad (Figure 27).



FIG. 27

2. Check the dust collection bag for fullness. Replace bag when half full (Figure 28).

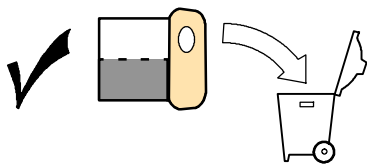

FIG. 28

3. Check vacuum hose for clogging. Clean hose as necessary (Figure 29).



FIG. 29

4. Charge batteries (Figure 30). See BATTERIES for charging instructions.



ON- BOARD CHARGER

OFF- BOARD CHARGER

FIG. 30

AFTER WEEKLY USE

Check the electrolyte level in all batteries (Figure 31). See BATTERIES for further details.

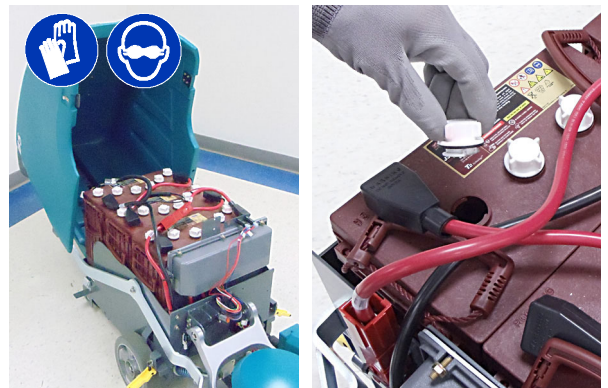

FIG. 31

MAINTENANCE

AFTER EVERY 50 HOURS OF USE

1. Check the dust skirt for wear or damage (Figure 32). Replace if worn or damaged.



FIG. 32

2. Clean the burnishing head and pad motor of any dust buildup using an air pressure hose (Figure 33). Maximum air pressure 100 psi / 690 kPa.

FOR SAFETY: When servicing machine, wear appropriate personal protection equipment as needed

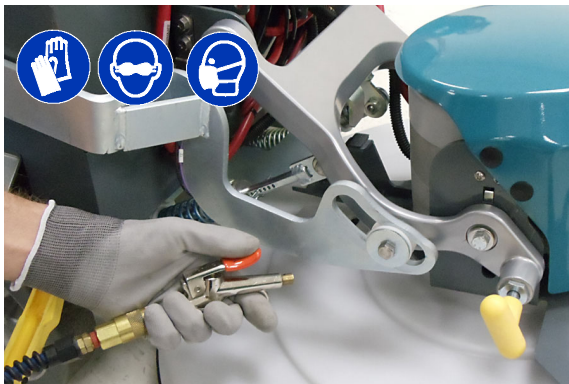

FIG. 33

3. Clean the outside surface of the machine with an all purpose cleaner and damp cloth (Figure 34).



FIG. 34

AFTER EVERY 100 HOURS OF USE

If machine is equipped with the optional HydroLINK battery watering system, check the watering hoses and connections for damage and wear (Figure 35). Replace system if damaged.

FOR SAFETY: When servicing batteries, wear personal protection equipment as needed. Avoid contact with battery acid.



FIG. 35

AFTER EVERY 200 HOURS OF USE

1. Clean batteries and check for loose battery cable connections (See BATTERY MAINTENANCE).
2. Replace the HEPA filter if model is equipped with the active dust control collection option (Figure 36).

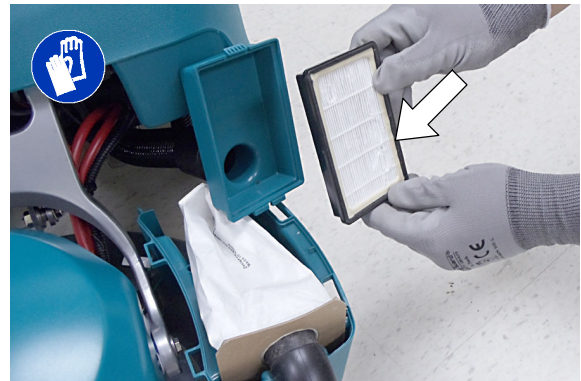

FIG. 36

AFTER EVERY 1000 HOURS OF USE

Inspect the four bushings at the head lift bracket assembly for wear (Figure 37). If you experience head bounce or vibration, have the bushings replaced.

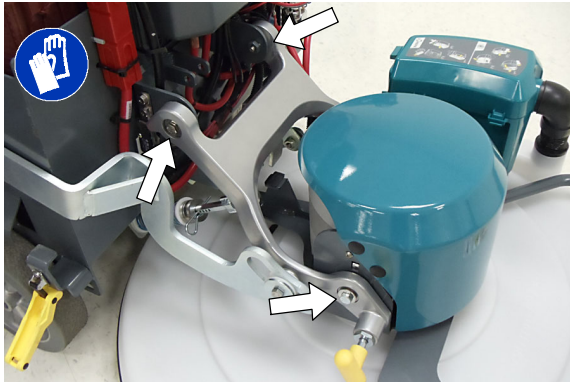

FIG. 37

MOTOR MAINTENANCE

Replace motor carbon brushes as indicated. Contact trained personnel for carbon brush replacement.

Carbon Brush Replacement	Hours
Propel Motor (Drive Model)	750
Pad Motor	1000

BATTERIES

FOR SAFETY: Before servicing machine, stop on level surface, turn off machine, remove key and set parking brake if equipped.

The lifetime of the batteries depends on their proper maintenance. To get the most life from the batteries;

- Do not charge the batteries more than once a day and only after running the machine for a minimum of 15 minutes.
- Do not leave the batteries partially discharged for long period of time.
- Only charge the batteries in a well-ventilated area to prevent gas build up. Charge batteries in areas with ambient temperatures 27°C (80°F) or less.
- Allow the charger to complete charging the batteries before re-using the machine.
- Maintain the proper electrolyte levels of flooded (wet) batteries by checking levels weekly.

Your machine is equipped with either flooded (wet) lead- acid or maintenance- free batteries supplied by Tennant.

FOR SAFETY: When servicing machine, keep all metal objects off batteries. Avoid contact with battery acid.

MAINTENANCE- FREE BATTERIES

Maintenance- free (Sealed AGM) batteries do not require watering. Cleaning and other routine maintenance is still required.

FLOODED (WET) LEAD- ACID BATTERIES

The flooded (wet) lead- acid batteries require routine watering as described below. Check the battery electrolyte level weekly.

*NOTE: **Do Not** check the electrolyte level if the machine is equipped with the battery watering system. Proceed to the BATTERY WATERING SYSTEM (OPTION).*

The level should be slightly above the battery plates as shown before charging. Add distilled water if low. **DO NOT OVERFILL.** The electrolyte will expand and may overflow when charging. After charging, distilled water can be added up to about 3 mm (0.12 in) below the sight tubes.

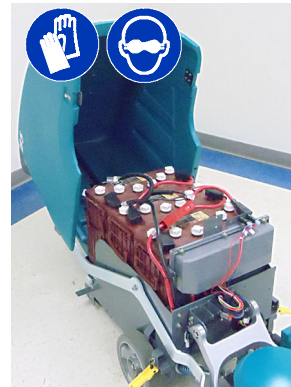

Before Charging

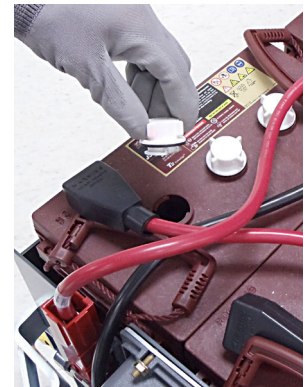
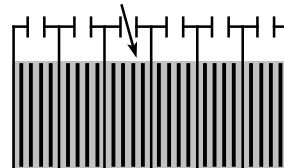

After Charging

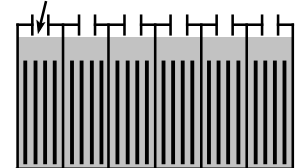

FIG. 38

NOTE: Make sure the battery caps are in place while charging. There may be a sulfur smell after charging batteries. This is normal.

CHECKING CONNECTIONS / CLEANING

After every 200 hours of use, check for loose battery connections and clean the surface of the batteries, including terminals and cable clamps to prevent battery corrosion. Use a scrub brush with a strong mixture of baking soda and water (Figure 39). Do not remove battery caps when cleaning batteries.



FIG. 39

CHARGING BATTERIES

The charging instructions in this manual are intended for the battery charger supplied with your machine. The use of other battery chargers that are not supplied and approved by Tennant are prohibited. If your machine is equipped with an off-board battery charger refer to the charger's owners manual for operating instructions. Contact distributor or Tennant for battery charger recommendations if machine is not equipped with charger.

FOR SAFETY: The use of incompatible battery chargers may damage battery packs and potentially cause a fire hazard.

If the on-board battery charger detects a problem while in use, the machine will display a service code. See *SERVICE INDICATOR CODES*. For off-board battery charger error codes refer to the manual supplied with charger.

Battery Charger Specifications:

- CHARGER TYPE:
 - For wet (Lead acid) Batteries
 - For Sealed (AGM) Batteries
- OUTPUT VOLTAGE - 36 VOLTS
- OUTPUT CURRENT - 25 AMPS
- AUTOMATIC SHUTOFF CIRCUIT
- FOR DEEP CYCLE BATTERY CHARGING

IMPORTANT NOTICE: The battery charger is set to charge the battery type supplied with your machine. If you choose to change to a different battery type or capacity (i.e. flooded (wet) lead-acid, maintenance-free, sealed, AGM batteries, etc.), the battery charger and the machine's battery discharge indicator (BDI) must be reprogrammed to prevent battery damage. See *BATTERY CHARGER SETTINGS*.

1. Transport the machine to a well-ventilated area.

⚠ WARNING: Fire Or Explosion Hazard. Batteries emit hydrogen gas. Explosion or fire can result. Keep sparks and open flame away when charging.

2. Park the machine on a flat, dry surface, turn off machine and remove key.

FOR SAFETY: When servicing batteries, stop on level surface, turn off machine, remove key and set parking brake if equipped.

3. If the machine is equipped with flooded (wet) lead-acid batteries check the battery electrolyte level weekly before charging. See *FLOODED (WET) LEAD-ACID BATTERIES*.
4. For models equipped with on-board chargers, remove the charger's power cord from the storage hooks and plug power cord into a properly grounded wall outlet (Figure 40).



FIG. 40

For models equipped with off-board chargers, first connect the charger's DC cord into the machine's battery charge receptacle then plug the AC power supply cord into a properly grounded wall outlet (Figure 41). Refer to the off-board battery charger's owner manual for operating instructions.

FOR SAFETY: Do not disconnect the off-board charger's DC cord from the machine's receptacle when the charger is operating. Arcing may result. If the charger must be interrupted during charging, disconnect the AC power supply cord first.

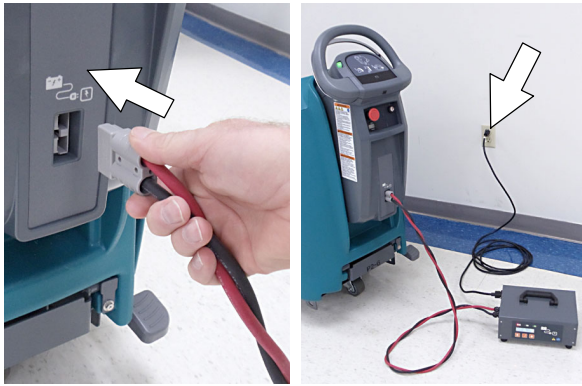

FIG. 41

- The charger will automatically begin charging and shut off when fully charged. The maximum charging cycle may take up to 6- 10 hours depending on battery type.

On- board battery charger: The battery discharge indicator lights will ripple back and forth during the charging cycle. When all five lights are flashing, the charging cycle is complete (Figure 42).

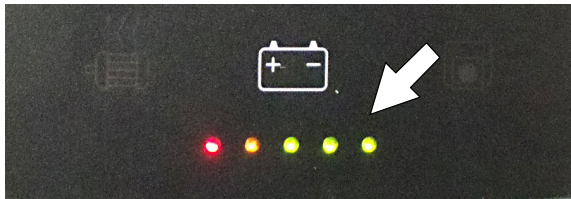

FIG. 42

- After charging batteries unplug the power supply cord and wrap cord around the cord hooks (Figure 43).

For models equipped with an off- board charger, always disconnect the AC power supply cord first before disconnecting charger from machine.



FIG. 43

BATTERY CHARGER SETTINGS

The battery charger is set to charge the battery type supplied with your machine. If you choose to change to a different battery type or capacity, the battery charger and the machine's battery discharge indicator (BDI) must be reprogrammed to prevent battery damage.

On- board Charger Models: To reprogram, Service Application Software is required, contact service. If the Service Application Software is not available, as an alternative, the settings can also be manually changed as described below.

Off- board Charger Models: For machine's equipped with an off- board battery changer, Service Application Software is required to change the BDI setting. Contact Service. After the BDI is reprogrammed, refer to the off- board charger's owner manual to change charging profile settings.

To manually change the On- board battery charger settings for a different battery type :

NOTE: This manual method is only an alternative if unable to change settings by use of the Service Application Software performed by Service.

- Unwrap the battery charger power cord from the cord hooks.
- Using a T25 star screwdriver, remove the two screws located at the bottom of the control console to access battery charger (Figure 44).

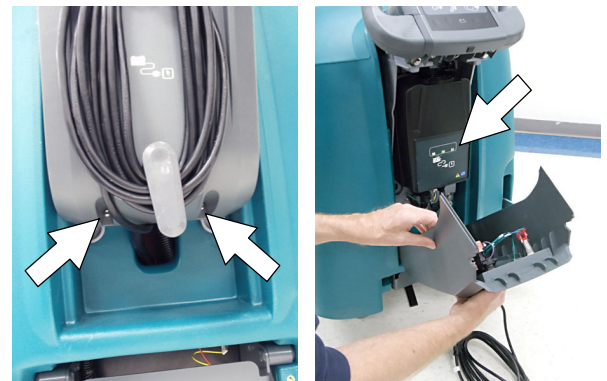

FIG. 44

MAINTENANCE

- Carefully peel back the charger display label to access the dial settings (Figure 45).

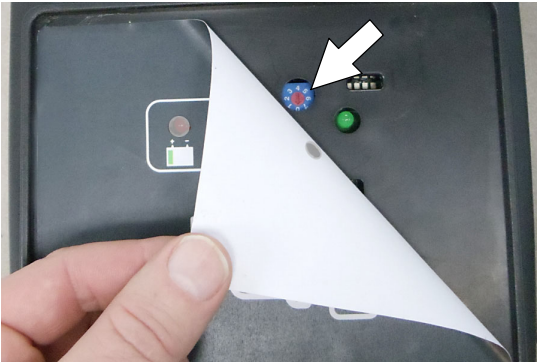

FIG. 45

- Using a small standard screwdriver, turn the dial to the appropriate battery type according to the following chart (Figure 46).

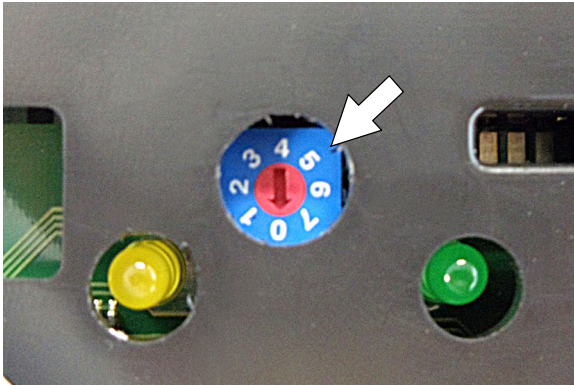

FIG. 46

* The CAN-BUS setting, dial position "0", is the software setting that is programmed to match battery type supplied with machine. When the dial is manually changed to a different setting, it should not be reset back to "0" otherwise battery damage may result. Service Application Software is required to reset dial back to "0". Contact Service.

Dial Position	Battery Description Settings
0	CAN- BUS setting*
1	Wet, Trojan 180- 250 AH
2	Wet, Trojan 260- 360 AH
3	Wet, EnerSys 200- 350 AH
4	AGM, Discover 200- 300 AH
5	AGM, Fullriver 200- 350 AH
6	Gel, Sonnenschein 150- 250 AH

- Re-apply the display label.
- Replace the control console.
- To set the BDI to the new battery type, plug the on-board battery charger cord into an electrical outlet. The machine's software will automatically reprogram the BDI to the new battery type.

HYDROLINK® BATTERY WATERING SYSTEM (OPTION)

The following instructions are for models equipped with the HydroLINK battery watering system option.

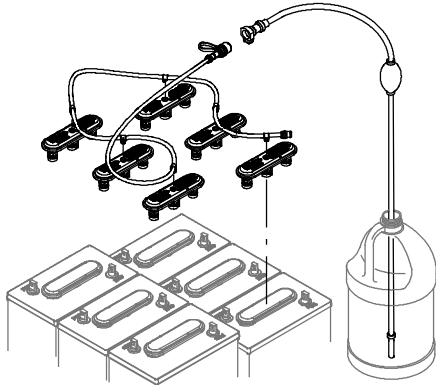

The optional HydroLINK battery watering system provides a safe and easy way to maintain the proper electrolyte levels in your batteries.

This battery watering system is also offered as an aftermarket kit (p/n 9010301). It is designed exclusively for Trojan® flooded (wet) lead-acid batteries.

FOR SAFETY: When servicing machine, wear personal protection equipment as needed. Avoid contact with battery acid.

Before using the battery watering system check hoses and connections for damage or wear.

1. Fully charge batteries prior to using the battery watering system. Do not add water to batteries before charging, the electrolyte level will expand and may overflow when charging.
2. After charging batteries, check the battery electrolyte level indicators located on the battery covers (Figure 47). If the level indicator is white add water as described in the following instructions. If the level indicators are black the electrolyte is at the correct level, no water is required.



FIG. 47

3. Locate the battery fill hose coupler inside the battery compartment. Remove the dust cap and connect the hand pump hose (Figure 48).

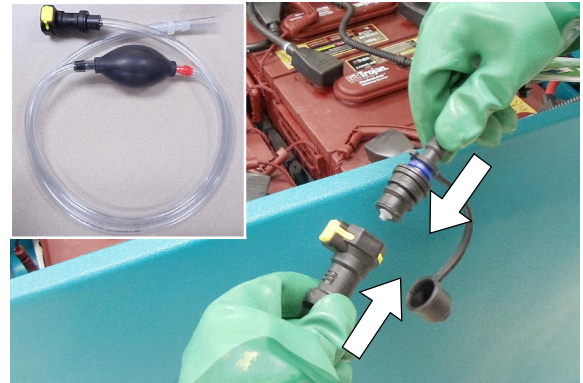

FIG. 48

4. Submerge the other end of the hand pump hose into a bottle of distilled water (Figure 49).



FIG. 49

5. Squeeze the bulb on the hand pump hose until firm (Figure 50). The level indicators will turn black when full.

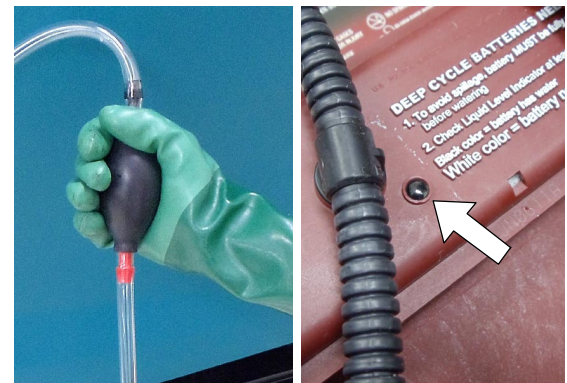

FIG. 50

6. After adding water, replace the dust cap on the battery fill hose and store the hand pump hose inside the machine's battery compartment for future use.

MACHINE JACKING

FOR SAFETY: Before leaving or servicing machine, stop on level surface, turn off machine and remove key.

Use the designated jacking locations for jacking up the machine (Figure 51). Use a jack capable of supporting the weight of the machine. Position the machine on a flat, level surface and block the tires before jacking.

FOR SAFETY: When servicing machine, jack machine up at designated locations only. Use jack or hoist that will support machine weight. Block machine up with jack stands.

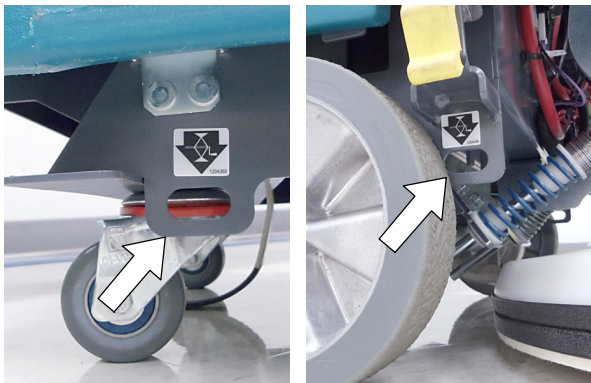

FIG. 51

LOADING/UNLOADING MACHINE FOR TRANSPORTING

When transporting the machine by use of trailer or truck, carefully follow the loading and tie-down procedure:

1. Raise the burnishing head to the transport position to prevent potential head damage when ramp loading machine on truck or trailer (Figure 52).

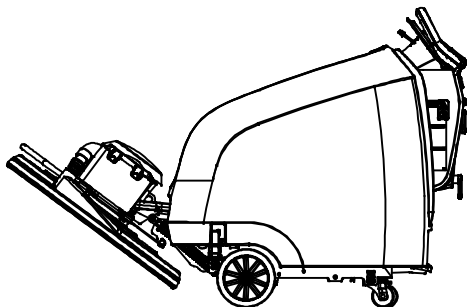
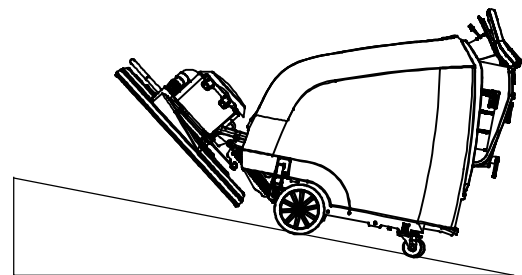

FIG. 52

2. Use a ramp that can support the machine weight and operator and carefully load machine. Do not operate the machine on a ramp incline that exceeds a 19.5% grade level (Figure 53). A winch must be used when ramp incline exceeds a 19.5% grade level.

FOR SAFETY: When loading/unloading machine onto/off truck or trailer, use a ramp that can support the machine weight and operator.

Do not operate the machine on a ramp incline that exceeds a 19.5% grade level. Use tie-down straps to secure machine to truck or trailer.



19.5% maximum ramp grade

FIG. 53

3. Once loaded, position the front of the machine up against the front of the trailer or truck. Lower the burnishing head to the floor and turn the key off (Figure 54).
4. Place a block behind each wheel (Figure 54).
5. Using tie-down straps, secure the front and rear of the machine using the four tie-down brackets located on the machine frame (Figure 54). It may be necessary to install tie-down brackets to the floor of your trailer or truck. Do not use the burnishing head lift pedal as a tie down.

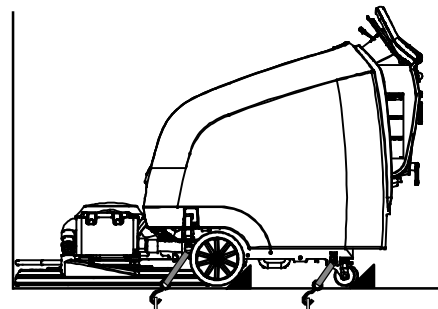

FIG. 54

6. When unloading machine, carefully back the machine down the ramp. Do not unload machine going in the forward direction.

STORING MACHINE

The following steps should be taken when storing the machine for extended periods of time.

1. Charge the batteries before storing machine to prolong the life of the batteries. Recharge batteries every 3 months.
2. Raise the burnishing head off the floor.
3. Park the machine in a cool, dry area.
4. Turn machine off and remove key.

NOTE: To prevent potential machine damage store machine in a rodent and insect free environment.

⚠ WARNING: To Reduce the Risk of Fire, Explosion, Electric Shock or Injury do not expose the machine to rain, store indoors.

5. For storage areas with limited space, raise the head as shown (Figure 55).

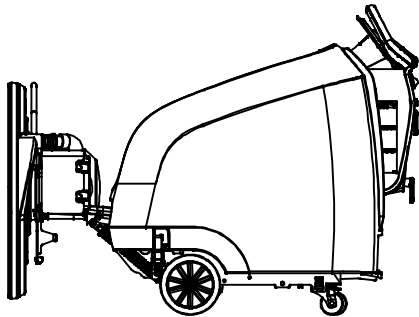

FIG. 55

MAINTENANCE

TROUBLESHOOTING

PROBLEM	CAUSE	SOLUTION
Service indicator symbol is flashing.	Machine or on-board battery charger fault has been detected	See SERVICE INDICATOR CODES in manual
No power	Emergency stop button activated	Turn button to reset
	Batteries discharged	Recharge batteries
	Loose or disconnected battery cable	Secure battery cable connections
	Circuit breaker tripped	Reset circuit breaker
	Faulty key switch	Contact Service Center
Machine does not propel (Drive Model)	Propel fault has been detected.	See SERVICE INDICATOR CODES in manual
	Circuit breaker tripped	Reset circuit breaker
	Faulty propel motor or wiring	Contact Service Center
	Worn carbon brushes in motor	Contact Service Center
Pad motor does not operate	Low voltage interrupter activated	Recharge batteries
	Pad motor fault has been detected.	See SERVICE INDICATOR CODES in manual
	Faulty pad motor or wiring	Contact Service Center
	Worn carbon brushes in motor	Contact Service Center
Vacuum motor does not operate (Active Dust Collection Model)	Vacuum motor fault has been detected	See SERVICE INDICATOR CODES in manual
	Faulty vacuum motor or wiring	Contact Service Center
	Circuit breaker tripped on vacuum	Reset circuit breaker button
Push model is not brush assisted	Burnishing head angle not properly adjusted	Contact Service Center
Battery charger will not operate	Batteries over discharged	Replace batteries
	Battery charger fault detected	See SERVICE INDICATOR CODES in manual
	Faulty charger	Replace charger
Poor burnishing performance	Worn pad	Flip or replace pad
	Pad pressure incorrect	Adjust pad pressure
		See Setting Pad Pressure
Short run time	Low battery charge	Charge batteries
	Batteries need maintenance	See BATTERY MAINTENANCE.
	Defective battery or end of battery life	Replace batteries
	Battery discharge indicator (BDI) programmed incorrectly	See CHARGING BATTERIES
	Pad pressure too high	Decrease pad pressure
		See Setting Pad Pressure
Faulty charger	Replace battery charger	
Machine vibration	Pad not properly centered	Remove and reinstall pad
	Improper pad for application	Change to proper pad
	Pad unevenly worn	Replace pad
	Soiled pad	Replace pad
	Worn head lift bracket bushings	Inspect, replace bushings

B5 GENERAL MACHINE DIMENSIONS/CAPACITIES/PERFORMANCE

MODEL	B5 (20 in / 510 mm) Push Model	B5 (20 in / 510 mm) Drive Model
Length	59 in / 1499 mm	59 in / 1499 mm
Width	24.5 in / 622 mm	24.5 in / 622 mm
Height	43 in / 1092 mm	43 in / 1092 mm
Weight	193 lb / 87.5 kg	198 lb / 90 kg
Weight with batteries	507 lb / 230 kg	572 lb / 259 kg
Cleaning path width	20 in / 510 mm	20 in / 510 mm
Productivity rate (max.)	16,260 ft ² /hr / 1,500 m ² /hr	20,000 ft ² /hr / 1,900 m ² /hr
Productivity rate (practical)	13,500 ft ² /hr / 1,200 m ² /hr	18,000 ft ² /hr / 1,670 m ² /hr
Burnishing speeds (variable)	Pad Assist	Min: 100 fpm / 30 mpm Max: 200 fpm / 60 mpm
Transport speed (max.)	n/a	Fwd: 240 fpm/ 73 mpm Rev: 144 fpm/ 44 mpm
Aisle turn (min.)	60 in / 1524 mm	60 in / 1524 mm
Grade level (max.)	Burnishing: 9%, Transport:19.5%	Burnishing: 9%, Transport:19.5%
Propel motor	n/a	24 V, 14 A, .363 hp / .27 kW , 271 W
Pad motor	36 V, 75 A, 2.8 hp max / 2.1 kW	36 V, 75 A, 2.8 hp max / 2.1 kW
Pad pressure	Variable	Variable
Pad speed	2100 rpm	2100 rpm
Vacuum motor (Active Dust Collection)	36 V, 5 A, 180W / 0.18 kW	36 V, 5 A, 180W / 0.18 kW
HEPA filtration (Active Dust Collection)	99.97% @0.3 micron	99.97% @0.3 micron
Filtration (Passive Dust Collection)	95% @0.3 micron	95% @0.3 micron
Dust bag capacity	1.27 qt / 1.4 L	1.27 qt / 1.4 L
Machine Voltage	36 VDC	36 VDC
Battery capacity	3 - 12V, 185 Ah Wet/lead- acid (std.) 3 - 12V, 225 Ah Wet/lead- acid (opt.) 3 - 12V, 234 Ah AGM (opt.)	3 - 12V, 225 Ah Wet/lead- acid (std.) 3 - 12V, 234 Ah AGM (opt.)
Total power consumption	60 A / 1.9 kw nominal	60 A / 1.9 kw nominal
Battery charger	120- 240 VAC, 50- 60 Hz, 36VDC, 25 A	120- 240 VAC, 50- 60 Hz, 36VDC, 25 A
Protection grade	IPX3	IPX3
Sound pressure level L _{pA} * (Active Dust Collection Model)	64 dB(A)	64 dB(A)
Sound pressure level L _{pA} * (Passive Dust Collection Model)	65 dB(A)	65 dB(A)
Sound Uncertainty K _{pA} **	1.1 dB(A)	1.1 dB(A)
Sound power level L _{wA} + uncertainty K _{wA} **	79.7 dB(A)	79.7 dB(A)
Machine vibration at hand- arm***	<2.5 m/s ²	<2.5 m/s ²
Ambient operating temperature	Min: 32°F/0°C Max: 110°F/43°C	Min: 32°F/0°C Max: 110°F/43°C

Values per * EN ISO- 11201, ** EN ISO- 3741, *** EN 60335- 2- 72

Specifications are subject to change without notice.

SPECIFICATIONS

B7 GENERAL MACHINE DIMENSIONS/CAPACITIES/PERFORMANCE

MODEL	B7 (24 in / 610 mm) Drive Model	B7 (27 in / 690 mm) Drive Model
Length	61.5 in / 1562 mm	63 in / 1602 mm
Width	30 in / 762 mm	31.5 in / 800 mm
Height	43 in / 1092 mm	43 in / 1092 mm
Weight	246 lb / 111.5 kg	254 lb / 115 kg
Weight with batteries	616 lb / 279 kg	797 lb / 361 kg
Cleaning path width	24 in / 610 mm	27 in / 690 mm
Productivity rate (max.)	24,000 ft ² /hr / 2,200 m ² /hr	27,000 ft ² /hr / 2,500 m ² /hr
Productivity rate (practical)	22,000 ft ² /hr / 2,000 m ² /hr	25,000 ft ² /hr / 2,300 m ² /hr
Burnishing speeds (variable)	Min: 100 fpm / 30 mpm Max: 200 fpm / 60 mpm	Min: 100 fpm / 30 mpm Max: 200 fpm / 60 mpm
Transport speed (max.)	Fwd: 240 fpm/ 73 mpm Rev: 144 fpm/ 44 mpm	Fwd: 240 fpm/ 73 mpm Rev: 144 fpm/ 44 mpm
Aisle turn (min.)	62.5 in / 1588 mm	64 in / 1626 mm
Grade level (max.)	Burnishing: 9%, Transport:19.5%	Burnishing: 9%, Transport:19.5%
Propel motor	24 V, 14 A, .363 hp / .27 kW , 271 W	24 V, 14 A, .363 hp / .27 kW , 271 W
Pad motor	37 V, 90 A, 3.6 hp max / 2.6 kW	37 V, 90 A, 3.6 hp max / 2.6 kW
Pad pressure	Variable	Variable
Pad speed	1875 rpm	1875 rpm
Vacuum motor (Active Dust Collection)	36 V, 5 A, 180W / 0.18 kW	36 V, 5 A, 180W / 0.18 kW
HEPA filtration (Active Dust Collection)	99.97% @0.3 micron	99.97% @0.3 micron
Filtration (Passive Dust Collection)	95% @0.3 micron	95% @0.3 micron
Dust bag capacity	1.27 qt / 1.4 L	1.27 qt / 1.4 L
Machine Voltage	36 VDC	36 VDC
Battery capacity	6 - 6V, 240 Ah Wet/lead- acid (std.) 6 - 6V, 312 Ah AGM (opt.) 6 - 6V, 360 Ah Wet/lead- acid (opt.)	6 - 6V, 330 Ah Wet/lead- acid (std.) 6 - 6V, 312 Ah AGM (opt.) 6 - 6V, 360 Ah Wet/lead- acid (opt.)
Total power consumption	75 A / 2.7 kw nominal	75 A / 2.7 kw nominal
Battery charger	120- 240 VAC, 50- 60 Hz, 36VDC, 25 A	120- 240 VAC, 50- 60 Hz, 36VDC, 25 A
Protection grade	IPX3	IPX3
Sound pressure level L _{pA} * (Active Dust Collection Model)	63 dB(A)	63 dB(A)
Sound pressure level L _{pA} * (Passive Dust Collection Model)	65 dB(A)	65 dB(A)
Sound Uncertainty K _{pA} **	1.1 dB(A)	1.1 dB(A)
Sound power level L _{wA} + uncertainty K _{wA} **	79.7 dB(A)	79.7 dB(A)
Machine vibration at hand- arm***	<2.5 m/s ²	<2.5 m/s ²
Ambient operating temperature	Min: 32°F/0°C Max: 110°F/43°C	Min: 32°F/0°C Max: 110°F/43°C

Values per * EN ISO- 11201, ** EN ISO- 3741, *** EN 60335- 2- 72

Specifications are subject to change without notice.

B5 MACHINE DIMENSIONS

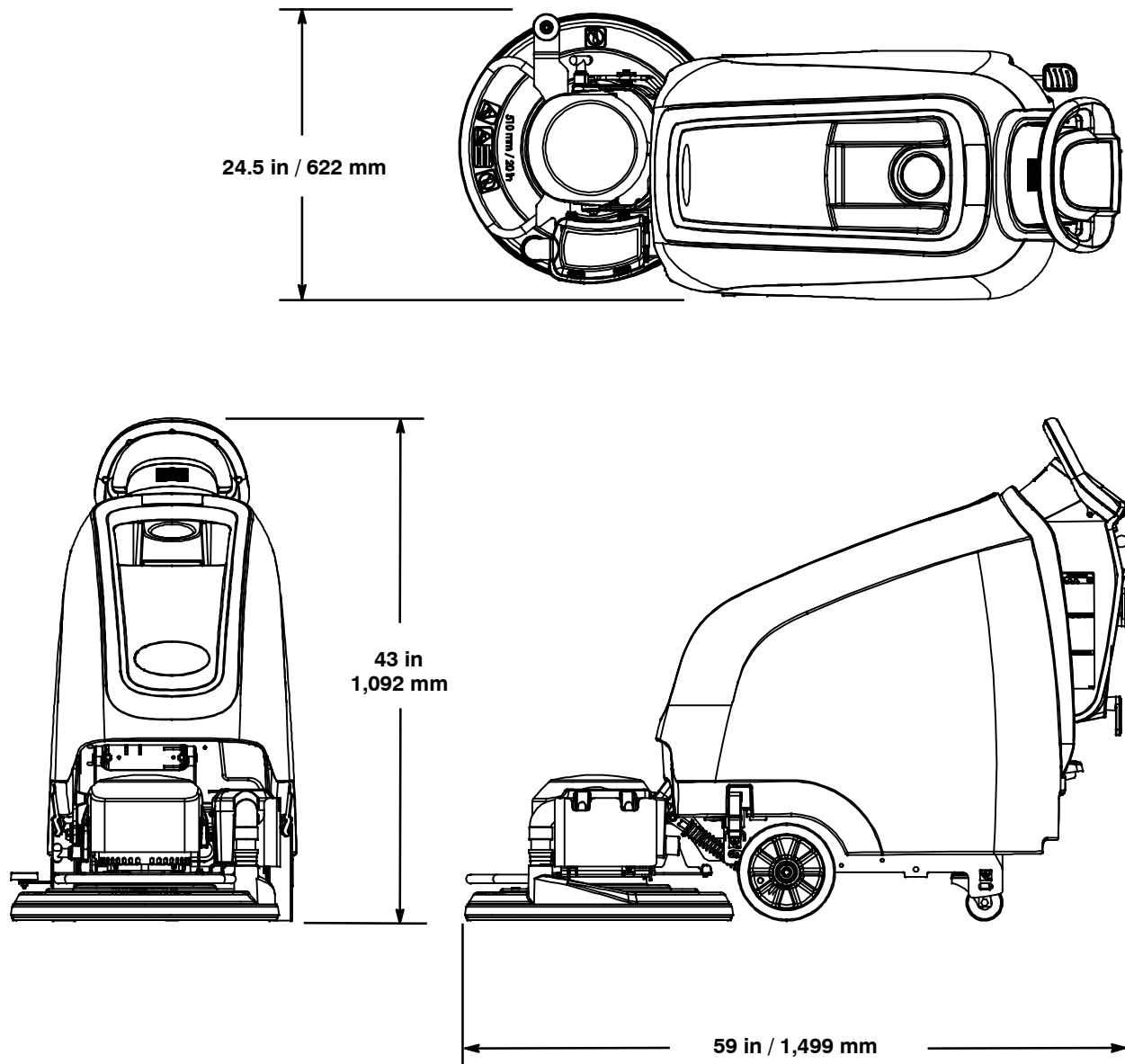

SPECIFICATIONS

B7 MACHINE DIMENSIONS

