

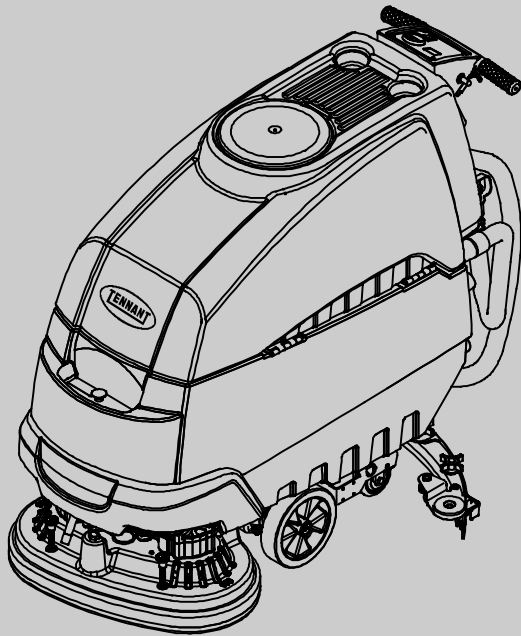

T5e

Walk-Behind Scrubber

English **EN**
Operator Manual



The Safe Scrubbing Alternative[®]
TennantTrue[®] Parts
IRIS[®] a Tennant Technology



North America / International



For the latest Parts manuals and other language Operator manuals, visit:

www.tennantco.com/manuals

9002337
Rev. 06 (10-2015)



OPERATION

This manual is furnished with each new model. It provides necessary operation and maintenance instructions.

Read this manual completely and understand the machine before operating or servicing it.

This machine will provide excellent service. However, the best results will be obtained at minimum costs if:

- The machine is operated with reasonable care.
- The machine is maintained regularly - per the machine maintenance instructions provided.
- The machine is maintained with manufacturer supplied or equivalent parts.



PROTECT THE ENVIRONMENT

Please dispose of packaging materials, old machine components such as batteries, hazardous fluids, including anti-freeze and oil, in an environmentally safe way according to local waste disposal regulations.



Always remember to recycle.

INTENDED USE

The T5e walk-behind scrubber is designed to scrub hard surfaces (concrete, asphalt, stone, synthetic, etc) in an indoor environment. Typical applications include hotels, schools, hospitals, factories, shops, offices, and rental businesses. Do not use this machine on carpeted surfaces. Use only recommended pads and commercially available floor cleaners intended for machine application. Do not use this machine other than described in this Operator Manual.

MACHINE DATA

Please fill out at time of installation for future reference.

Model No. - _____

Serial No. - _____

Installation Date - _____

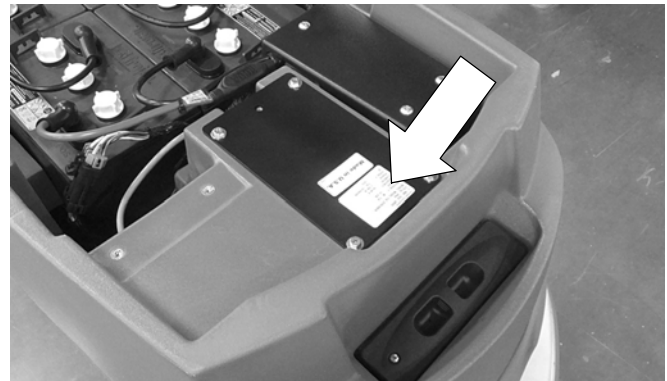

TENNANT Company
PO Box 1452
Minneapolis, MN 55440
Phone: (800) 553- 8033 or (763) 513- 2850

www.tennantco.com

Tennant Cleaning Systems & Equipment Co., Ltd
Building 1, No. 3777 Caoying Road
Qingpu Shanghai, China 201712
电话 Phone: 86 21 6922 5333
传真 Fax: 86 21 69225151
www.tennantco.com.cn

FaSK- PAK and Insta-Fit are US registered and unregistered trademarks of Tennant Company.

Specifications and parts are subject to change without notice.

Copyright © 2006-2015 TENNANT COMPANY
All rights reserved.

TABLE OF CONTENTS

IMPORTANT SAFETY INSTRUCTIONS	4	ADJUSTING SCRUB HEAD BRUSHES	24
SAFETY LABELS	6	DISK MODEL	24
MACHINE COMPONENTS	7	CYLINDRICAL BRUSH MODEL	25
CONTROL PANEL COMPONENTS	8	MACHINE MAINTENANCE	27
MACHINE INSTALLATION	9	DAILY MAINTENANCE	27
UNCRATING MACHINE	9	MONTHLY MAINTENANCE	29
INSTALLING BATTERIES	9	BATTERY MAINTENANCE	30
HOW THE MACHINE WORKS	10	SQUEEGEE BLADES	31
BRUSH AND PAD INFORMATION	10	MOTOR MAINTENANCE	31
MACHINE SETUP	10	FaST SYSTEM MAINTENANCE	32
ATTACHING SQUEEGEE ASSEMBLY	10	ec-H ₂ O NanoClean WATER CONDITIONING	
INSTALLING BRUSHES/PADS	11	CARTRIDGE REPLACEMENT	32
ec-H ₂ O NanoClean WATER CONDITIONING		ec-H ₂ O MODULE FLUSH PROCEDURE ...	33
CARTRIDGE (ec-H ₂ O NanoClean model) ..	12	JACKING UP MACHINE	34
INSTALLING FaST-PAK CARTON		TRANSPORTING MACHINE	34
(FaST Model)	13	STORING MACHINE	34
FILLING SOLUTION TANK	13	FREEZE PROTECTION	35
ADJUSTING CONTROL CONSOLE HEIGHT	13	TROUBLESHOOTING	37
MACHINE OPERATION	14	BATTERY METER LED FAULT CODES	39
PRE- OPERATION CHECKS	14	MACHINE SPECIFICATIONS	40
STARTING THE MACHINE	14	MACHINE DIMENSIONS	41
EMERGENCY STOPPING	16		
WHILE OPERATING MACHINE	16		
BATTERY METER	17		
HOUR METER	17		
CIRCUIT BREAKERS / FUSES	17		
OFF- AISLE WAND SETUP			
AND OPERATION	18		
PREPARING MACHINE FOR OFF- AISLE WAND			
SCRUBBING:	18		
OPERATING THE OFF- AISLE WAND:	18		
DRAINING AND CLEANING TANKS	19		
DRAINING RECOVERY TANK	19		
DRAINING SOLUTION TANK	19		
CHARGING BATTERIES	20		
BATTERY CHARGER SPECIFICATIONS ...	20		
ON- BOARD BATTERY CHARGER			
SETTINGS	20		
USING THE ON- BOARD BATTERY CHARGER			
(220- 240V Chargers)	21		
USING THE ON- BOARD BATTERY CHARGER			
(120V Chargers)	21		
ON- BOARD BATTERY CHARGER ERROR			
CODES	23		
USING AN OFF- BOARD BATTERY			
CHARGER	23		

IMPORTANT SAFETY INSTRUCTIONS - SAVE THESE INSTRUCTIONS

The following warning precautions are used throughout this manual as indicated in their description:

⚠ WARNING: To warn of hazards or unsafe practices which could result in severe personal injury or death.

FOR SAFETY: To identify actions which must be followed for safe operation of equipment.

The following information signals potentially dangerous conditions to the operator. Know when these conditions can exist. Locate all safety devices on the machine. Report machine damage or faulty operation immediately.

⚠ WARNING: Fire Or Explosion Hazard

- **Never Use Flammable Liquids Or Operate Machine In Or Near Flammable Liquids, Vapors Or Combustible Dusts.**

This machine is not equipped with explosion proof motors. The electric motors will spark upon start up and during operation which could cause a flash fire or explosion if machine is used in an area where flammable vapors/liquids or combustible dusts are present.

- **Do Not Pick Up Flammable Materials Or Reactive Metals.**
- **Batteries Emit Hydrogen Gas. Keep Sparks And Open Flame Away. Keep Battery Compartment Open When Charging.**

⚠ WARNING: Electrical Hazard

- **Disconnect Battery Cables and Charger Plug Before Servicing Machine.**
- **Do Not Charge Batteries with Damaged Power Supply Cord. Do Not Modify Plug.**

If the charger supply cord is damaged or broken, it must be replaced by the manufacturer or its service agent or a similarly qualified person in order to avoid a hazard.

⚠ WARNING: Spinning Brush. Keep Hands Away. Turn Off Power Before Working On Machine.

This machine may be equipped with technology that automatically communicates over the cellular network. If the machine will be operated where cell phone use is restricted because of concerns related to equipment interference, please contact a Tennant representative for information on how to disable the cellular communication functionality.

WARNING: This machine contains chemicals known to the state of California to cause cancer, birth defects, or other reproductive harm.

FOR SAFETY:

1. **Do not operate machine:**
 - **Unless trained and authorized.**
 - **Unless operator manual is read and understood.**
 - **Under the influence of alcohol or drugs.**
 - **While using cell phone or other electronic devices.**
 - **Unless mentally and physically capable of following machine instructions.**
 - **If not in proper operating condition.**
 - **In areas where flammable vapors/liquids or combustible dusts are present.**
 - **In areas that are too dark to safely see the controls or operate the machine.**
 - **In areas with possible falling objects.**
 - **With pads or accessories not supplied or approved by Tennant. The use of other pads may impair safety.**
 - **In outdoors areas. This machine is for indoor use only.**
2. **Before starting machine:**
 - **Check machine for fluid leaks.**
 - **Make sure all safety devices are in place and operate properly.**
3. **When using machine:**
 - **Use only as described in this manual.**
 - **Go slowly on inclines and slippery surfaces.**
 - **Wear closed-toe non-slip shoes.**
 - **Reduce speed when turning.**
 - **Use care when reversing machine.**
 - **Do not carry passengers on machine.**
 - **Keep children and unauthorized persons away from machine.**
 - **Do not allow machine to be used as a toy.**
 - **Always follow safety and traffic rules.**
 - **Report machine damage or faulty operation immediately.**
 - **Follow mixing and handling instructions on chemical containers.**
 - **Follow site safety guidelines concerning wet floors.**
 - **Do not scrub on inclines that exceed 5% grade or transport on inclines that exceed 8%.**

4. **Before leaving or servicing machine:**
 - Stop on level surface.
 - Set parking brake, if equipped.
 - Turn off machine and remove key.
5. **When servicing machine:**
 - All work must be done with sufficient lighting and visibility.
 - Keep work area well ventilated.
 - Avoid moving parts. Do not wear loose clothing, jewelry and secure long hair.
 - Block machine tires before jacking machine up.
 - Jack machine up at designed locations only. Support machine with jack stands.
 - Use hoist or jack that will support the weight of the machine.
 - Do not power spray or hose off machine.
 - Disconnect battery connections and battery charger before working on machine.
 - Keep all metal objects off batteries.
 - The use of incompatible battery chargers may damage battery packs and potentially cause a fire hazard.
 - Inspect charger cord regularly for damage.
 - Do not disconnect the charger DC cord from the machine receptacle when charger is operating. Arcing may result. If the charger must be interrupted during charging, disconnect the AC power supply cord first.
 - Avoid contact with battery acid.
 - Use a hoist or adequate assistance when lifting batteries.
 - All repairs must be performed by trained personnel.
 - Do not modify the machine from its original design.
 - Use Tennant supplied or approved replacement parts.
 - Wear personal protective equipment as needed and where recommended in this manual.
6. **When loading/unloading machine onto/off truck or trailer:**
 - Drain tanks before loading machine.
 - Lower scrub head and squeegee before tying down machine.
 - Turn off machine and remove key.
 - Use a ramp, truck or trailer that will support the weight of the machine and operator.
 - Use a winch if ramp incline exceeds a 19.5% grade level.
 - Set parking brake, if equipped.
 - Block machine wheels.
 - Use tie-down straps to secure machine.



For Safety: wear protective gloves.



For Safety: wear eye protection.

OPERATION

SAFETY LABELS

The safety labels appear on the machine in the locations indicated. Replace labels if they are missing or become damaged or illegible.

WARNING LABEL - Located on recovery tank cover.

	⚠ WARNING	⚠ AVERTISSEMENT	⚠ ADVERTENCIA
  	EXPLOSION, FIRE AND SHOCK HAZARD. AVOID INJURY. <ul style="list-style-type: none">• Do Not Use or Pick Up Flammable Materials.• Do Not Use Near Flammable Liquids, Vapors or Combustible Dusts.• Keep Sparks and Open Flame Away When Charging Batteries. Keep Battery Hood Open When Charging.• Disconnect Battery Cables and Charger Cord Before Servicing.	RISQUE D'EXPLOSION, D'INCENDIE ET DE DÉCHARGE. ÉVITEZ LES BLESSURES. <ul style="list-style-type: none">• N'utilisez Pas ou Ne Ramassez Pas de Matériaux Inflammables.• N'utilisez Pas Près de Liquides, Vapeurs ou Poussières Inflammables.• Éloignez les Sources d'Étincelles ou de Flamme Ouverte Lors du Chargement des Batteries. Laissez Ouvert le Capot du Compartiment des Batteries Lors de la Mise en Charge.• Débranchez les Câbles de Batterie et le Cordon du Chargeur Avant l'Entretien.	PELIGRO DE EXPLOSIÓN, FUEGO, DESCARGA EVITE LESIONES. <ul style="list-style-type: none">• No Use O Recoja Materiales Flammables.• No Use Cerca De Líquidos Flammables, Vapores O Materiales Combustibles.• Mantenga Chispas Y Fuego Alejados Mientras Carga Baterías. Mantenga Tapa De Batería Abierta Mientras Carga.• Desconecte Cable De Batería Y Cable Del Cargador Antes Del Mantenimiento.



BATTERY CHARGE LABEL -

Located on bottom side of recovery tank.

⚠ WARNING: Fire Or Explosion Hazard. Batteries Emit Hydrogen Gas. Keep Sparks And Open Flame Away. Keep Battery Compartment Open When Charging.



SPINNING BRUSH LABEL -

Located on scrub head

⚠ WARNING: Spinning Brush. Keep Hands Away. Turn Off Power Before Working On Machine.

MACHINE COMPONENTS

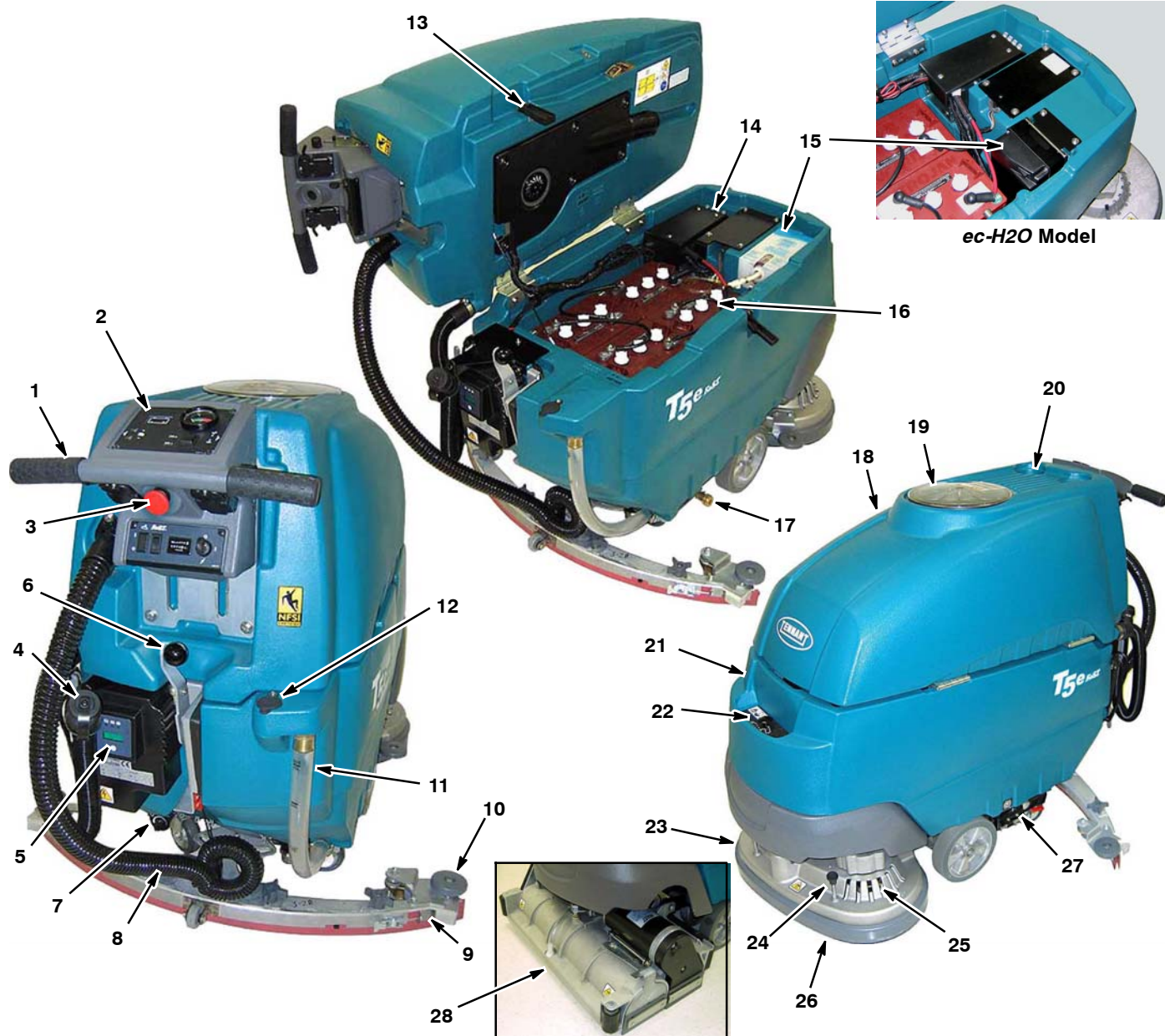

- | | |
|--|---|
| <ul style="list-style-type: none"> 1. Adjustable Control Console 2. Control Panel 3. Emergency Stop Button (option) 4. Recovery Tank Drain Hose 5. On-board Battery Charger 6. Squeegee Lift Lever 7. Solution Flow Control Knob 8. Squeegee Vacuum Hose 9. Squeegee Assembly 10. Wall Rollers 11. Solution Tank Level/Drain Hose 12. Rear Fill Port 13. Recovery Tank Support Stand 14. Circuit Breaker Panel | <ul style="list-style-type: none"> 15. FaST-PAK Carton Compartment (FaST Model) ec-H2O System Module (ec-H2O Model) 16. Batteries 17. Off-Aisle Wand Solution Hose Coupler 18. Recovery Tank 19. Recovery Tank Cover 20. Cup Holders 21. Solution Tank 22. Front Fill Port 23. Disk Scrub Head 24. Pad Release Plunger 25. Pad Driver Window 26. Scrub Head Skirt 27. Parking Brake (option) 28. Cylindrical Brush Scrub Head |
|--|---|

OPERATION

CONTROL PANEL COMPONENTS



ec-H2O Model

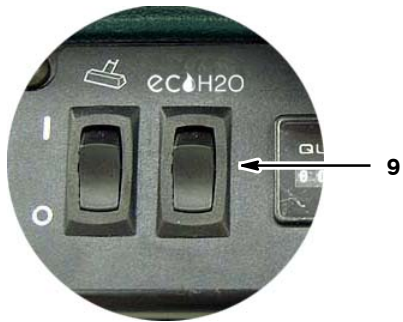

ec-H2O Model



- | | |
|---|--|
| <ul style="list-style-type: none"> 1. Battery Meter 2. Reverse Trigger 3. Start Triggers 4. Brush Pressure Meter 5. Control Console Height Adjustment Lever 6. Speed Control Knob | <ul style="list-style-type: none"> 7. Brush Pressure Switch 8. Off-Aisle Wand on/off Switch (option) 9. FaST system on/off switch (FaST Model)
<i>ec-H2O system on/off switch (ec-H2O Model)</i> 10. <i>ec-H2O system indicator light (ec-H2O Model)</i> 11. Main Power on/off Key Switch 12. Hour Meter |
|---|--|

MACHINE INSTALLATION

UNCRATING MACHINE

- Carefully check the shipping crate for signs of damage. Report damage at once to carrier.
- Check the contents list. Contact distributor for missing items.
Contents:
 - 4- 6 V Batteries- Optional
 - 3- Battery Cable Jumpers
 - Battery Tray
 - 1- FaST- PAK 365 Concentrate- (FaST Model)
 - Squeegee Assembly
 - 2- Pad drivers (Disk Model)
 - 2- Brushes (Cylindrical Brush Model)
- To uncrate your machine, remove the shipping hardware and straps that secure the machine to the pallet. Carefully back machine down ramp.

ATTENTION: Do not roll machine off pallet unless a ramp is used, machine damage may occur.

ATTENTION: To prevent possible machine damage, install batteries *after* removing machine from shipping pallet.

INSTALLING BATTERIES

⚠ WARNING: Batteries emit hydrogen gas. Explosion or fire can result. Keep sparks and open flame away. Keep battery compartment open when charging.

FOR SAFETY: When servicing machine, wear personal protection equipment as needed. Avoid contact with battery acid.

Battery Specifications:

Four 6 volt, 235A/20h deep cycle batteries. Maximum battery dimensions:
7.5 in/190 mm W x 10.8 in/275 mm L x 11 in/284 mm H.

- Park the machine on a level surface, remove the key and set the parking brake, if equipped.

FOR SAFETY: Before leaving or servicing machine, stop on level surface, set parking brake if equipped, turn off machine and remove key.

- Carefully install the batteries into the battery compartment tray (Figure 1). Arrange the battery posts as shown (Figure 2).



FIG. 1

- Connect the battery cables to the battery posts as shown (Figure 2), RED TO POSITIVE (+) and BLACK TO NEGATIVE (-).

235 A/20Ah

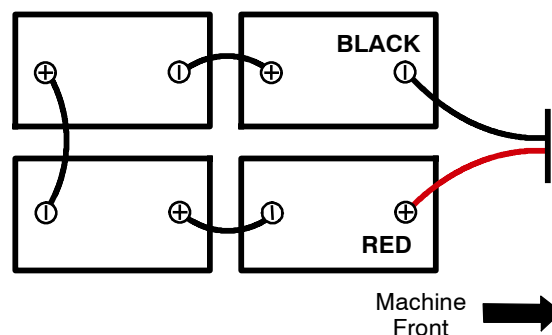

FIG. 2

IMPORTANT: If your machine is equipped with the on-board battery charger, make sure that the charger is properly set for your battery type before charging (See ON-BOARD CHARGER SETTINGS).

OPERATION

HOW THE MACHINE WORKS

Conventional Scrubbing:

Water and detergent from the solution tank flow to the floor through a solution valve. The brushes use the detergent and water to scrub the floor clean. As the machine moves forward, the squeegee wipes the dirty solution from the floor into the recovery tank.

ec-H2O NanoClean Scrubbing (ec-H2O Model):

When using the ec-H2O NanoClean technology, normal water passes through a module where it is electrically converted into a cleaning solution. The electrically converted water attacks the dirt, allowing the machine to easily scrub away the suspended soil. The converted water then returns to normal water in the recovery tank.

Foam Scrubbing (FaST Model):

(FaST- Foam activated Scrubbing Technology)
Unlike conventional scrubbing, the FaST system injects the FaST- PAK concentrate formula with a small amount of water and air onto the floor. The mixture creates a large volume of expanded wet foam for the brush to scrub the floor clean. As the machine moves forward, the foam collapses and the squeegee recovers the dirty solution into the recovery tank leaving the floor clean, dry and slip free.

BRUSH AND PAD INFORMATION

For best cleaning results use the appropriate brush type for your cleaning application. Refer to the Parts manual for part number information.

Polypropylene Bristle Scrub Brush (Black) -

This general purpose polypropylene bristle scrub brush is used for scrubbing lightly compacted soilage. This brush works well for maintaining concrete, wood and grouted tile floors.

Soft Nylon Bristle Scrub Brush (White) -

Recommended for cleaning coated floors without removing finish. Cleans without scuffing.

Super Abrasive Bristle Scrub Brush (Gray) -

Nylon fiber impregnated with abrasive grit to remove stains and soilage. Strong action on any surface. Performs well on buildup, grease, or tire marks.

Polishing Pad (White) -

Used to maintain highly polished or burnished floors.

Buffing Pad (Red) - Used for light duty scrubbing without removing floor finish.

Scrubbing Pad (Blue) - Used for medium to heavy-duty scrubbing. Removes dirt, spills, and scuffs and leaves surface clean and ready for recoating.

Stripping Pad (Brown) - Used for stripping of floor finish to prepare the floor for recoating.

Heavy Duty Stripping Pad (Black) - Used for aggressive stripping of heavy finishes/sealers, or very heavy duty scrubbing.

MACHINE SETUP

ATTACHING SQUEEGEE ASSEMBLY

FOR SAFETY: Before leaving or servicing machine, stop on level surface, set parking brake if equipped, turn off machine and remove key.

1. Park the machine on a level surface, remove the key and set the parking brake if equipped.
2. Lift the squeegee lift lever to the upward position (Figure 3).



FIG. 3

3. Mount the squeegee assembly to the squeegee pivot bracket and secure with knobs (Figure 4).



FIG. 4

4. Connect the vacuum hose to the squeegee assembly. Loop the hose as shown using the hose clip provided (Figure 5).

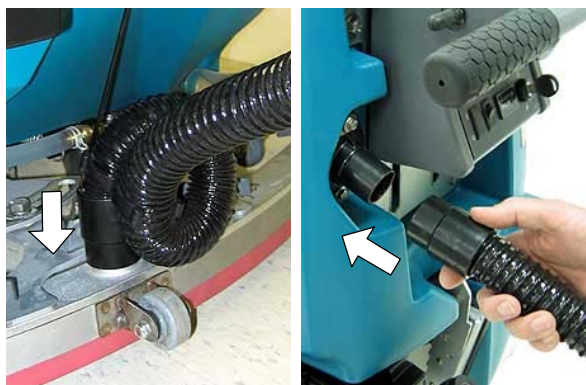

FIG. 5

5. Check the squeegee blades for proper deflection. The blades should deflect as shown (Figure 6).



FIG. 6

6. To adjust the blade deflection, place the squeegee assembly on a level surface and adjust the casters as shown (Figure 7).

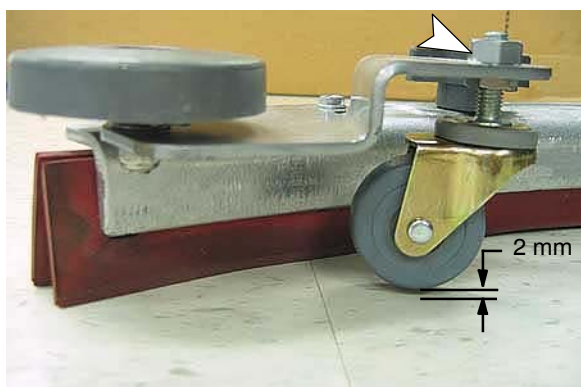

FIG. 7

INSTALLING BRUSHES/PADS

FOR SAFETY: Before leaving or servicing machine, stop on level surface, set parking brake if equipped, turn off machine and remove key.

Disk Model:

1. Raise scrub head off the floor and remove key.
2. Attach the pad to the pad driver before installing the driver. Secure pad with centerlock (Figure 8).

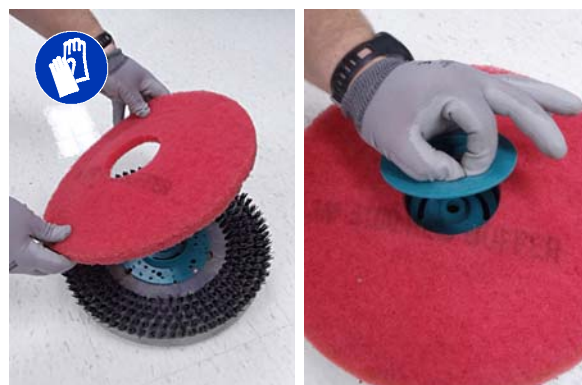

FIG. 8

3. Set the yellow spring clips to the open position to make brush installation easier. Press clips down and outward to set (Figure 9).

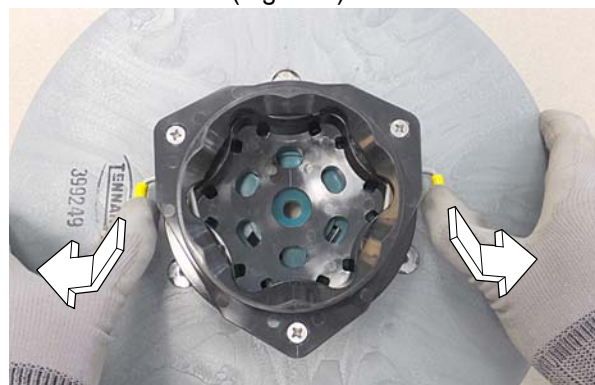

FIG. 9

4. Align the pad driver or brush under the motor hub and push it upward to engage hub (Figure 10).

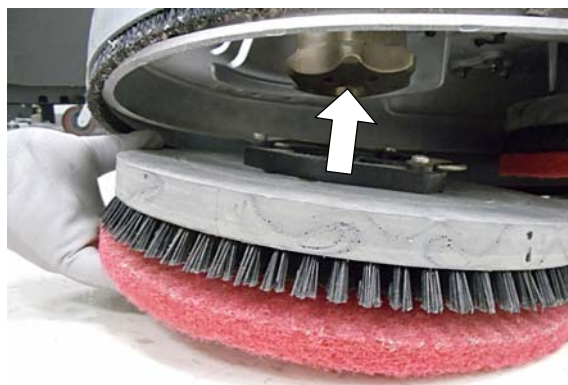

FIG. 10

OPERATION

- To remove the pad driver or brush, raise the scrub head and push the pad release plunger downward (Figure 11).



FIG. 11

- Check the scrub head to ensure that it is properly adjusted (See ADJUSTING SCRUB HEAD BRUSHES).

Cylindrical Brush Model:

- Raise scrub head off the floor and remove key.
- Remove idler plate from scrub head by pressing the spring tab downward (Figure 12).



FIG. 12

- Attach idler plate to the brush end that has the double row of bristles (Figure 13). Install brush.



FIG. 13

- Check the brushes to ensure they are properly adjusted (See ADJUSTING SCRUB HEAD BRUSHES).

ec-H₂O NanoClean WATER CONDITIONING CARTRIDGE (ec-H₂O NanoClean model)

(ec-H₂O models labeled ec-H₂O NanoClean)

The ec-H₂O system is equipped with a water conditioning cartridge. The cartridge is designed to protect the machine's plumbing system from potential scaling. The cartridge is located behind the right side brush motor (Figure 14).

The cartridge is required to be replaced when it reaches its maximum water usage or expiration time of when the cartridge was activated, whichever comes first.

Depending on machine usage a new cartridge can last anywhere from 12 to 24 months.



FIG. 14

All cartridges are labeled with a manufacture date. The shelf-life of an un-installed cartridge is one year from manufacture date. For new cartridge replacement, the ecH₂O module timer must be reset. See ec-H₂O NanoClean WATER CONDITIONING CARTRIDGE REPLACEMENT.

ATTENTION: During first time use and after replacing the water conditioning cartridge, the ec-H₂O system will automatically override the selected solution flow rate for up to 75 minutes.

The ec-H₂O system indicator light will blink green/red when it's time to replace cartridge (Figure 15).



FIG. 15

INSTALLING FaST- PAK CARTON (FaST Model)

ATTENTION: The FaST- PAK Concentrate Formula is specifically designed for the FaST system. **NEVER** use a substitute. Machine damage may result.

1. Pull out the hose connector from the FaST- PAK carton and remove cap (Figure 16).

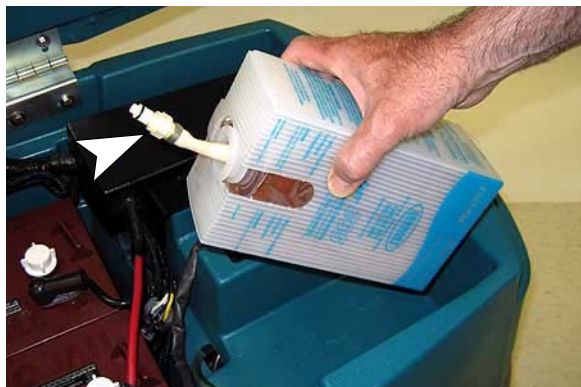

FIG. 16

2. Open the battery compartment. Connect the FaST- PAK carton to the supply hose and place carton in compartment (Figure 17). **Make sure the hose does not get pinched.**

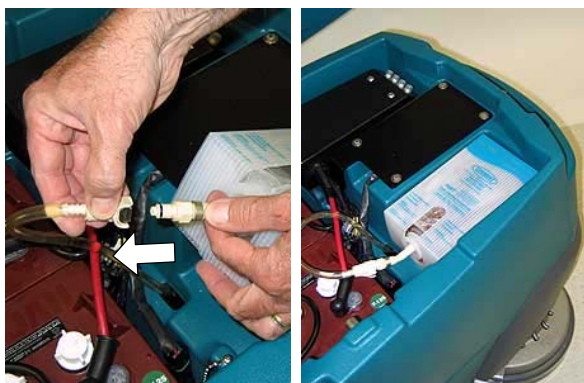

FIG. 17

3. When the supply hose is not in use, connect the storage plug to prevent the FaST system from drying out and clogging up the hose. (Figure 18).

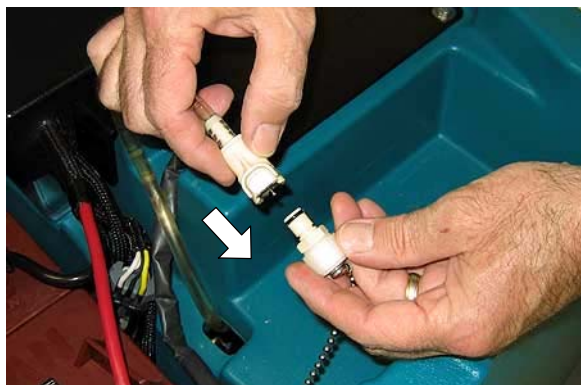

FIG. 18

FILLING SOLUTION TANK

FOR SAFETY: Before leaving or servicing machine, stop on level surface, set parking brake if equipped, turn off machine and remove key.

Using a hose or bucket, fill the solution tank to the "MAX 85L" mark (Figure 19).

For Conventional Scrubbing: Use hot water (140°F/60°C maximum). Pour a recommended cleaning detergent into the solution tank according to mixing instructions on the container.

For FaST or ec-H2O Scrubbing: Use cool clean water only (less than 70°F/21°C). Do not add any conventional floor cleaning detergents, system failure may result.



FIG. 19

ATTENTION: For Conventional Scrubbing, only use commercially approved cleaning detergents. Machine damage due to improper detergent usage will void the manufacturer's warranty.

⚠ WARNING: Flammable materials can cause an explosion or fire. Do not use flammable materials in tank(s).

ADJUSTING CONTROL CONSOLE HEIGHT

Pull the control console height adjustment lever and lift or lower the console to a comfortable operating height. Release lever to lock in position (Figure 20).

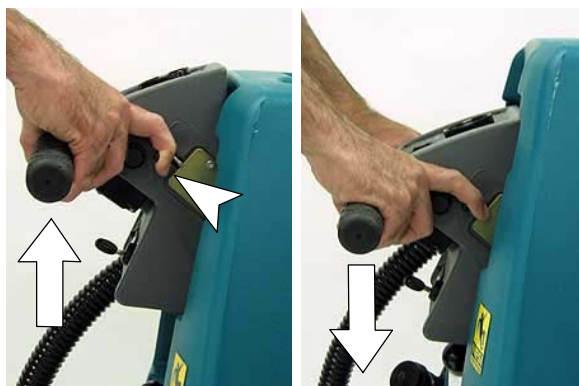

FIG. 20

OPERATION

MACHINE OPERATION

FOR SAFETY: Do not operate machine, unless operator manual is read and understood.

PRE- OPERATION CHECKS

- Sweep area.
- Check the battery meter.
- Check the brushes/pads for wear.
- Check the squeegee blades for wear and proper adjustment.
- Make sure the recovery tank is empty and the float shut-off screen is installed and clean.
- Check the scrub head skirt for wear.
- For FaST Scrubbing:** Check the FaST-PAK concentrate level.
- For FaST or ec-H2O Scrubbing:** Make sure the solution tank is filled with cool clean water only.
- For FaST or ec-H2O Scrubbing:** Ensure that all conventional cleaning agents are drained and rinsed from solution tank.

STARTING THE MACHINE

1. Release the parking brake if equipped (Figure 21).
2. Turn the key to the on (I) position (Figure 21).



FIG. 21

3. **FaST model:** Press the FaST system switch to the on (I) position (Figure 22).

ec-H2O model: Press the ec-H2O system switch to the on (I) position (Figure 22). The ec-H2O system indicator light will not turn on until the machine starts scrubbing.

ATTENTION: ec-H2O NanoClean models - During first time use and after replacing the water conditioning cartridge, the ec-H2O system will automatically override the selected solution flow rate for up to 75 minutes.



FIG. 22

IMPORTANT: NEVER turn the FaST/ec-H2O system switch on when conventional scrubbing. Conventional cleaning detergents/restorers may cause failure to the FaST/ec-H2O solution system. Drain, rinse and refill solution tank with cool clean water before operating the FaST/ec-H2O system.

4. Lower the squeegee assembly to the floor by lowering the squeegee lift lever (Figure 23).



FIG. 23

5. Lower the scrub head to the floor by pressing the brush pressure button (Figure 24).



FIG. 24

- Pull the triggers to begin scrubbing (Figure 25). To reverse the machine, simply pull the reverse trigger. Raise squeegee when reversing machine.

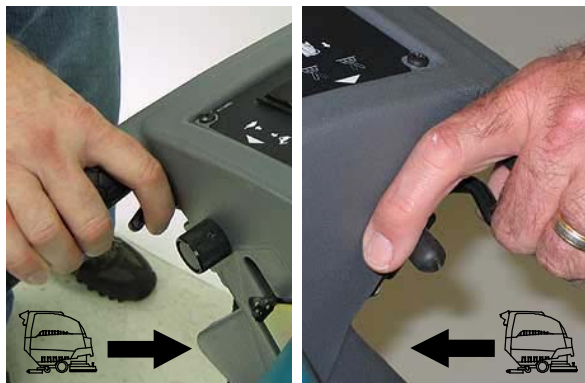

FIG. 25

- Adjust the speed control knob to a desired scrubbing speed (Figure 26).

NOTE: 45- 60 meters per minute is the recommended scrubbing speed.



FIG. 26

- Check the brush pressure meter reading and adjust the pressure if needed (Figure 27). Do not operate the machine in the red zone, floor damage or brush motor overload may result.

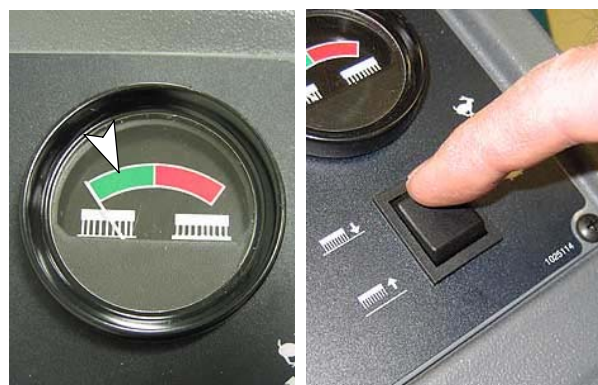

FIG. 27

- For conventional scrubbing, adjust the solution flow control knob to a desired flow rate (Figure 28).

NOTE: The solution flow cannot be adjusted when the machine is set for FaST scrubbing or for ec-H₂O scrubbing on ec-H₂O models manufactured before ec-H₂O NanoClean models.



FIG. 28

ec-H₂O NanoClean Models
(ec-H₂O models labeled ec-H₂O NanoClean)

To adjust the solution flow rate when ec-H₂O scrubbing, press the solution flow button located on the ec-H₂O module (Figure 29). One LED= low, two LED's=medium, and three LED's= high (Figure 29). The ec-H₂O module is located under the recovery tank. Drain recovery tank before lifting tank.



FIG. 29

- To stop scrubbing, release the triggers, raise the scrub head and squeegee and turn the key to the off position.

OPERATION

EMERGENCY STOPPING

Strike the emergency stop button, if equipped, in the event of an emergency (Figure 30). This button shuts off all power to machine. To regain power, turn the button clockwise.



FIG. 30



FIG. 31

WHILE OPERATING MACHINE

⚠ WARNING: Flammable materials or reactive metals can cause an explosion or fire. Do not pickup.

1. Overlap each scrub path by 2 in/5 cm.
2. Keep the machine moving to prevent damage to floor finish.
3. Do not operate the machine on inclines that exceed 5%. 
4. Conventional scrubbing: Pour a commercially approved foam control solution into the recovery tank if excessive foam appears.

ATTENTION: Do not allow foam to enter the float shut-off screen located in the recovery tank, vacuum motor damage will result. Foam will not activate the float shut-off screen.

5. For heavily soiled areas, use the double scrubbing method. First scrub the area with the squeegee up, let solution set for 3- 5 minutes, then scrub the area a second time with squeegee down.
6. When leaving the machine unattended, remove the key and set the parking brake, if equipped.
7. If the machine detects a fault, the battery meter will blink a fault code (See BATTERY METER LED FAULT CODES).

8. **ec-H2O NanoClean Models** (*ec-H2O models labeled ec-H2O NanoClean*)

If the ec-H2O system indicator light begins to blink green/red, the water conditioning cartridge needs to be replaced (Figure 31). See ec-H2O NanoClean WATER CONDITIONING CARTRIDGE REPLACEMENT.

ec-H2O SYSTEM INDICATOR LIGHT CODE	CONDITION
Solid green	Normal operation
Blinking green/red	Water conditioning cartridge expired. Replace cartridge.
Solid or blinking* red	Contact Service Center

**Verify if cleaning detergent was added to solution tank. If ec-H2O system was operated with cleaning detergent, drain solution tank, add clear water and operate the ec-H2O system until the indicator light code clears.*

ec-H2O Models (*ec-H2O models manufactured before ec-H2O NanoClean models*)

If an alarm sounds and the ec-H2O system indicator light begins to blink red, the ec-H2O module must be flushed to resume ec-H2O operation (See ec-H2O MODULE FLUSH PROCEDURE) (Figure 31).

NOTE: *When the alarm sounds and the light blinks red, the machine will bypass the ec-H2O system. To continue scrubbing, turn the ec-H2O switch off and change over to conventional scrubbing.*

ATTENTION: (ec-H2O model) Do not allow solution tank to run dry. ec-H2O module failure may result if operated without water for an extended period.

ec-H2O SYSTEM INDICATOR LIGHT CODE	CONDITION
Solid green	Normal operation
Blinking red	Flush ec-H2O module
Solid red	Contact Service Center

BATTERY METER

The battery meter displays the charge level of the batteries (Figure 32). When the batteries are fully charged, all indicator lights will glow. As the batteries discharge, the indicator lights will begin to go out from right to left

When the discharge level reaches the first red light (Figure 32), stop scrubbing and recharge the batteries. If you continue to operate the machine beyond the first red light, the scrubbing function will automatically shut off when the last red light begins to blink. This protects the batteries from total discharge. Drive the machine to the charging area and recharge the batteries immediately.

NOTE: The battery meter will also display machine fault codes. If a fault is detected the LED bars will flash specific fault codes (See BATTERY METER LED FAULT CODES).



FIG. 32

HOUR METER

The hour meter records the number of total hours the brush motors have been powered on. Use the hour meter to determine when to perform recommended maintenance procedures and to record service history (Figure 34). See MACHINE MAINTENANCE.



FIG. 33

CIRCUIT BREAKERS / FUSES

The machine is equipped with four resettable circuit breakers and four fuses to protect the machine from damage. If a breaker should trip, determine the cause, allow the motor to cool then manually reset the circuit breaker button. The circuit breaker panel is located near the battery compartment (Figure 34). The fuses are located inside the circuit breaker box. When replacing a fuse never substitute a higher Amp rated fuse than specified.

CIRCUIT BREAKERS:

- 10 A - Main (A)
- 25 A - Vacuum motor (B)
- 25 A - Left brush motor (C)
- 25 A - Right brush motor (D)

FUSES:

- 100 A - Main
- 30 A - Propel motor
- 7.5 A - FaST system
- 7.5 A - FaST system
- 7.5 A - Off-aisle wand pump (located in control console)

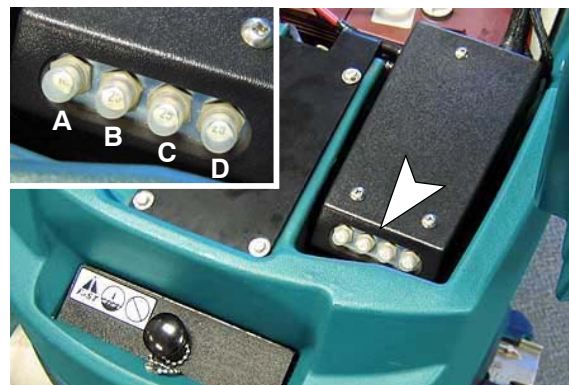

FIG. 34

OPERATION

OFF-AISLE WAND SETUP AND OPERATION

If your machine is equipped with the off- aisle wand option, this allows you to scrub areas where the machine is unable to reach.

Preparing Machine for Off- Aisle Wand Scrubbing:

1. Park the machine on a level surface, turn key off and set parking brake if equipped.
2. Connect the solution hose to the coupler at the lower right side of machine (Figure 35).



FIG. 35

3. Using the hose adapter, connect the squeegee hose to the wand hose (Figure 36).

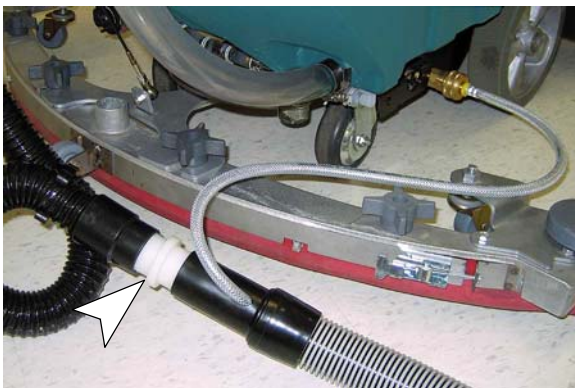

FIG. 36

4. Attach the off- aisle wand to the hoses (Figure 37).



FIG. 37

Operating the Off- Aisle Wand:

1. Turn the key and wand switch to the on (I) position (Figure 38). The FaST/ec-H2O system switch is disabled when operating the wand.



FIG. 38

2. Lower the squeegee to activate the vacuum motor (Figure 39).



FIG. 39

3. Squeeze trigger to activate solution. Use brush for scrubbing and squeegee for pickup (Figure 40).

⚠ WARNING: Flammable materials or reactive metals can cause an explosion or fire. Do not pickup.



FIG. 40

4. After scrubbing, turn off the wand switch and squeeze the trigger for five seconds to relieve the water pressure before disconnecting the solution hose.

DRAINING AND CLEANING TANKS

After each use, the tanks should be drained and cleaned.

FOR SAFETY: Before leaving or servicing machine, stop on level surface, set parking brake if equipped, turn off machine and remove key.

DRAINING RECOVERY TANK

1. Transport machine to disposal area and turn key switch off.
2. While holding the drain hose upward, remove the cap and lower hose to drain (Figure 41).



FIG. 41

3. Remove the recovery tank cover and rinse out the tank. Clean the float shut-off screen located inside the recovery tank (Figure 42).



FIG. 42

DRAINING SOLUTION TANK

1. To drain remaining water from the solution tank, pull the solution tank level hose off the hose fitting (Figure 43).



FIG. 43

2. On a monthly basis, remove the solution tank filter from underneath the machine and rinse out the screen (Figure 44). Make sure the solution tank is empty before removing filter.

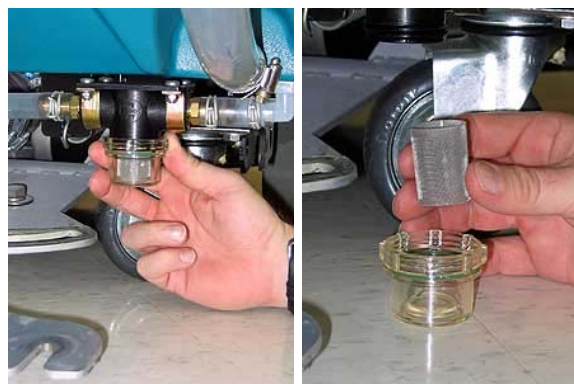

FIG. 44

OPERATION

CHARGING BATTERIES

FOR SAFETY: When servicing machine, wear personal protection equipment as needed. Avoid contact with battery acid.

The lifetime of the batteries depends on their proper maintenance. To get the most life from the batteries:

- Do not charge the batteries more than once a day and only after running the machine for a minimum of 15 minutes.
- Do not leave the batteries partially discharged for long period of time.
- Only charge the batteries in a well-ventilated area to prevent gas build up. Charge batteries in areas with ambient temperatures 80°F / 27°C or less.
- Allow the charger to complete charging the batteries before re-using the machine.
- Maintain the proper electrolyte levels of flooded (wet) batteries by checking levels weekly (See BATTERY MAINTENANCE).

⚠ WARNING: Batteries Emit Hydrogen Gas. Keep Sparks And Open Flame Away. Keep Battery Compartment Open When Charging.

BATTERY CHARGER SPECIFICATIONS

- CHARGER TYPE:
 - FOR SEALED (Gel) BATTERIES
 - FOR WET (Lead acid) BATTERIES
- OUTPUT VOLTAGE - 24 VOLTS
- OUTPUT CURRENT - 20 AMPS
- AUTOMATIC SHUTOFF CIRCUIT
- FOR DEEP CYCLE BATTERY CHARGING

ON-BOARD BATTERY CHARGER SETTINGS

If your machine is equipped with the on-board charger, the charger settings must be set for your battery type before charging. Failure to properly set will result in battery damage.

To determine your battery type, see battery label. Contact your battery supplier if not specified.

To verify the setting of the charger, connect the charger cord into an electrical receptacle. The charger will display a sequence of codes. One of the codes will either read "GEL" or "AcD" (Figure 45).

GEL = Set for sealed/maintenance free batteries
AcD = Set for wet/lead acid batteries



FIG. 45

To change the setting, unplug the charger, peel up the corner of the display label and set the switches accordingly (Fig. 46). The charger cord must be unplugged when resetting.

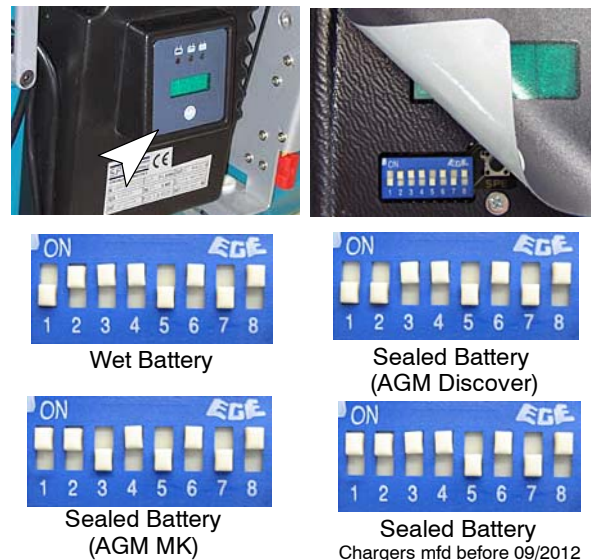

FIG. 46

**USING THE ON- BOARD BATTERY CHARGER
(220- 240V Chargers)**

IMPORTANT: Before charging, make sure that the charger setting is properly set for your battery type (See ON- BOARD CHARGER SETTINGS).

1. Transport the machine to a well- ventilated area.
2. Park the machine on a flat, dry surface. Turn the key off and set the parking brake, if equipped.
3. If charging wet (lead acid) batteries check the fluid level before charging (See BATTERY MAINTENANCE).
4. Prop up the recovery tank for ventilation (Figure 47).



FIG. 47

5. Connect the charger's AC power supply cord into a properly grounded receptacle (Figure 48).

NOTE: The machine will not operate when charging.

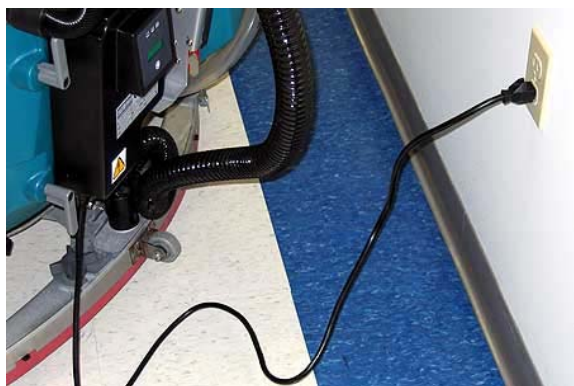

FIG. 48

6. The charger will display a sequence of codes once the cord is connected (Figure 49).

Three- digits + the following code:

A = Charging current

U = Battery voltage

h = Charging time

C = Charging ampere- hours [Ah]

E = Energy used [Kwh]

“GEL” or “Acd” = Battery type the charger is currently set for. Before charging make sure your battery type matches the display: GEL=Sealed, Acd=Wet (lead acid). To change setting, see ON- BOARD CHARGER SETTINGS.

Press the arrow button to review the codes.



FIG. 49

7. Once the charging cycle begins, the indicator lights will progress from red, yellow to green. When the green indicator light comes on, the charging cycle is done. Unplug the charger cord.

If the charger detects a problem, the charger will display an error code (See ON- BOARD BATTERY CHARGER ERROR CODES).

**USING THE ON- BOARD BATTERY CHARGER
(120V Chargers)**

IMPORTANT: Before charging, make sure that the charger setting is properly set for your battery type (See ON- BOARD CHARGER SETTINGS).

1. Transport the machine to a well- ventilated area.
2. Park the machine on a flat, dry surface. Turn the key off and set the parking brake, if equipped.
3. If charging wet (lead acid) batteries check the fluid level before charging (See BATTERY MAINTENANCE).
4. Open the battery compartment and attach the red handle battery connector harness to the battery charger connector as shown (Figure 50).

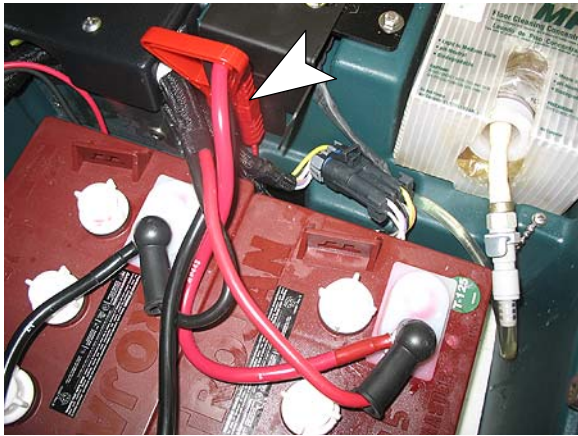

FIG. 50

5. Unwrap the battery charger's AC power cord from storage hooks located on the underside of the recovery tank (Figure 51).



FIG. 51

6. Connect the charger's AC power supply cord into a properly grounded receptacle (Figure 52).

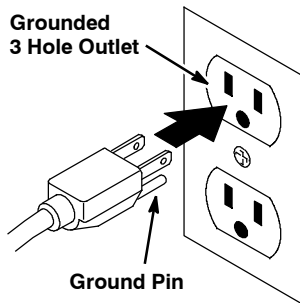

FIG. 52

7. Using the support stand, prop up the recovery tank to allow for proper ventilation when charging batteries (Figure 53).



FIG. 53

NOTE: The machine will not operate when charging.

8. At start up, the charger will display a sequence of codes (Figure 54).

Three- digits + the following code:

A = Charging current

U = Battery voltage

h = Charging time

C = Charging ampere- hours [Ah]

E = Energy used [Kwh]

"GEL" or "Acd" = Battery type the charger is currently set for. Before charging make sure your battery type matches the display:
GEL=Sealed, Acd=Wet (lead acid). To change setting, see ON- BOARD CHARGER SETTINGS.

Press the arrow button to review the codes.



FIG. 54

9. When the charging cycle begins, the indicator lights will progress from red, yellow to green. When the green indicator light comes on, the charging cycle is done.

If the charger detects a problem, the charger will display an error code (See ON- BOARD BATTERY CHARGER ERROR CODES).

- When the charge cycle is complete, unplug the AC cord and return cord to storage hooks then disconnect the red handle battery connector (Figure 55).

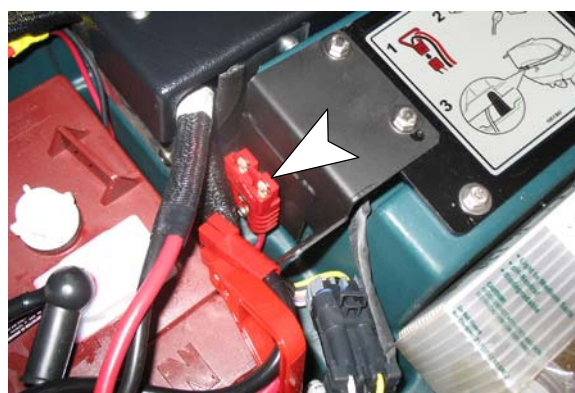

FIG. 55

ON- BOARD BATTERY CHARGER ERROR CODES

DISPLAY CODE	FAULT	SOLUTION
bat	Loose or damaged battery cable	Check battery cable connections.
	Battery exceeded maximum voltage level.	No action necessary.
E01	Exceeded maximum battery voltage allowed.	No action necessary.
E02	Safety thermostat exceeded maximum internal temperature.	Check if the charger vents are obstructed.
E03	Exceeded maximum time for charging phase leaving the batteries undercharged due to a sulfated or faulty battery.	Repeat the charging cycle and if the error code E03 reappears check battery or replace it.
SCt	Safety timer exceeded maximum charging time. Interrupts charging cycle.	Replace battery.
Srt	Possible internal short circuit.	Contact Service Center.

USING AN OFF- BOARD BATTERY CHARGER

FOR SAFETY: When servicing machine, the use of incompatible battery chargers may damage battery packs and potentially cause a fire hazard. Inspect charger cord regularly for damage.

- Transport the machine to a well-ventilated area.
- Park the machine on a flat, dry surface. Turn the key off and set the parking brake, if equipped.

FOR SAFETY: Before leaving or servicing machine, stop on level surface, set parking brake if equipped, turn off machine and remove key.

- If charging wet (lead acid) batteries, check the fluid level before charging (See BATTERY MAINTENANCE).

- Prop up the recovery tank for ventilation (Figure 56).



FIG. 56

- Connect the charger's AC power supply cord into a properly grounded receptacle.
- Connect the charger's DC cord into the machine's battery receptacle (Figure 57).



FIG. 57

7. The supplied charger will automatically begin charging and shut off when fully charged.

NOTE: The machine will not operate when charging.
ATTENTION: Do not disconnect the charger's DC cord from the machine's receptacle when the charger is operating. Arcing may result. If the charger must be interrupted during charging, disconnect the AC power supply cord first.

ADJUSTING SCRUB HEAD BRUSHES

To ensure optimum scrubbing performance periodically check the scrub head for proper adjustment.

FOR SAFETY: Before leaving or servicing machine, stop on level surface, set parking brake if equipped, turn off machine and remove key.

DISK MODEL

Tools required: Measuring device, 1- 1/16 in (27mm) wrench and 15/16 in (24mm) wrench.

1. With brushes installed, lower the scrub head and apply medium brush pressure.
2. Turn machine off and remove key.
3. From the center front and back of scrub head, measure the distance from the top edge of scrub head to the floor (Figure 58).

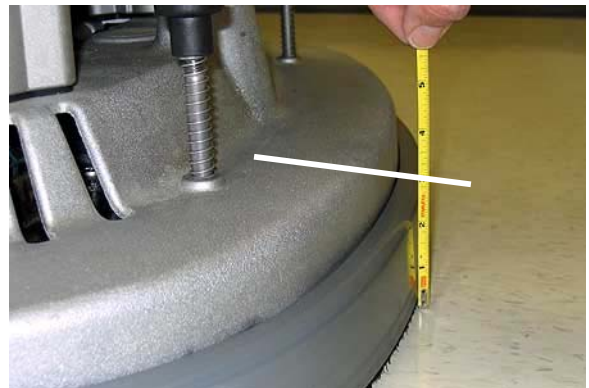

FIG. 58

4. If scrub head is not level, loosen the lock nut and turn the scrub head leveling screw to level. Tighten down the lock nut once head is level (Figure 59).



FIG. 59

CYLINDRICAL BRUSH MODEL

After installing a new set of cylindrical brushes check the brush pattern to ensure proper brush adjustment. Brushes that are not properly adjusted will result in premature wear and poor scrubbing performance (Figure 60).

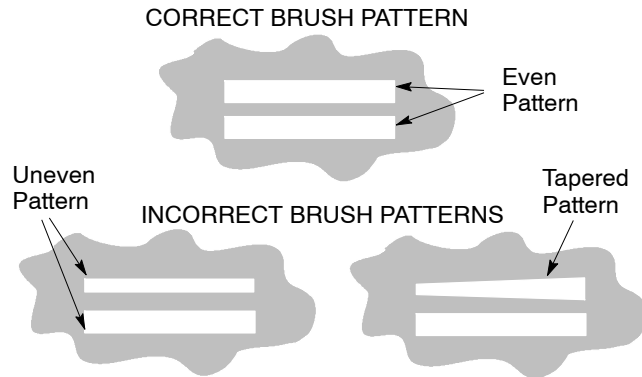

FIG. 60

To Inspect the Brush Pattern:

1. Position the machine on a dry dusty floor or apply a powdered substance, such as chalk.
2. Disconnect the drive motor wire connector to keep machine from moving forward (Figure 61).



FIG. 61

3. Lower the scrub head to the floor and apply maximum brush pressure.
4. Shut off the solution flow.
5. Pull the triggers to create a brush pattern on the floor.
6. Raise the scrub head and pull the machine away.
7. Observe the brush pattern on floor. If the brush pattern is uneven or tapered, adjustment is required.
8. Reconnect drive motor wire.

To Adjust an Uneven Brush Pattern:

Tools required: Measuring device, 27mm wrench and 24mm wrench

1. Measure the distance from the front edge of the scrub head to the floor and from the back edge of the scrub head to the floor (Figure 62). The measurements should be the same.



FIG. 62

2. To level the scrub head, loosen the lock nut and turn the leveling screw clockwise to lower the rear of the scrub head or counter-clockwise to lower the front (Figure 63).

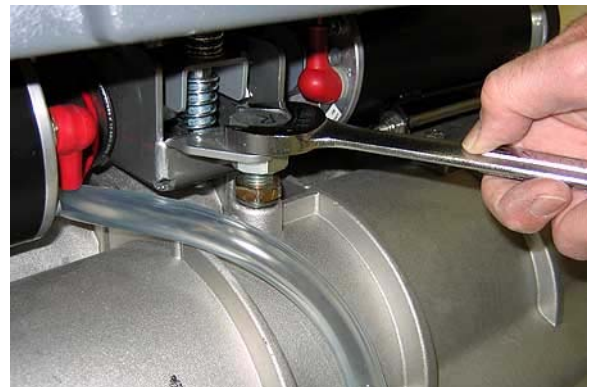

FIG. 63

3. Recheck brush pattern.

NOTE: Replace brushes when bristles are worn to 15 mm.

OPERATION

To Adjust a Tapered Brush Pattern:

Tools required: 10mm wrench and 6mm hex wrench

1. Raise the scrub head off floor and remove key.
2. Remove the idler plate from the brush (Figure 64).



FIG. 64

3. Hold the brush plug shaft with a wrench and loosen the 6mm hex screw (Figure 65).



FIG. 65

4. To lower the brush end, turn the shaft clockwise for the front brush and counter-clockwise for the rear brush. Retighten hex screw (Figure 66).



FIG. 66

5. Recheck brush pattern.

NOTE: Replace brushes when bristles are worn to 15 mm.

MACHINE MAINTENANCE

To keep the machine in good working condition, it's important that the following maintenance procedures are performed on a routine basis.

FOR SAFETY: Before leaving or servicing machine, stop on level surface, turn off machine, remove key and set parking brake if equipped.

FOR SAFETY: When servicing machine, wear personal protection equipment as needed.

DAILY MAINTENANCE (After Every Use)

1. Drain the recovery tank (Figure 67).



FIG. 67

2. Rinse out the recovery tank. Remove the recovery tank float shut-off screen and clean (Figure 68).

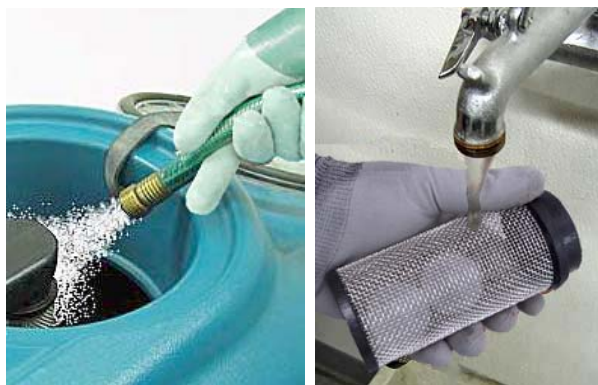

FIG. 68

3. Drain the solution tank (Figure 69).



FIG. 69

4. Rotate pad or replace when worn (Figure 70).

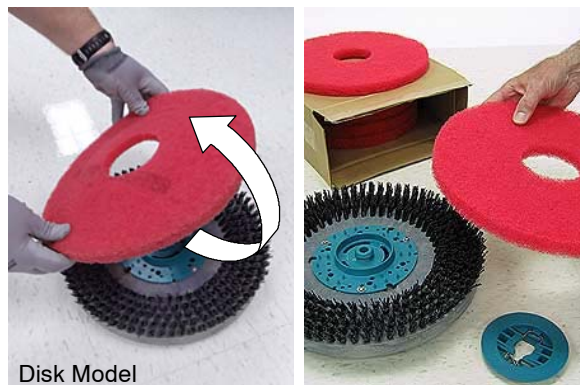

Disk Model

FIG. 70

5. Replace brushes when they no longer clean effectively or when the bristles are worn to the yellow indicator (Figure 71).



FIG. 71

6. Empty and rinse out the debris trough (Figure 72).



Cylindrical Brush Model

FIG. 72

OPERATION

7. Inspect the cylindrical brushes for wear. Rotate brushes from front-to-rear every 50 hours (Figure 73). Replace when worn to a length of 15mm.

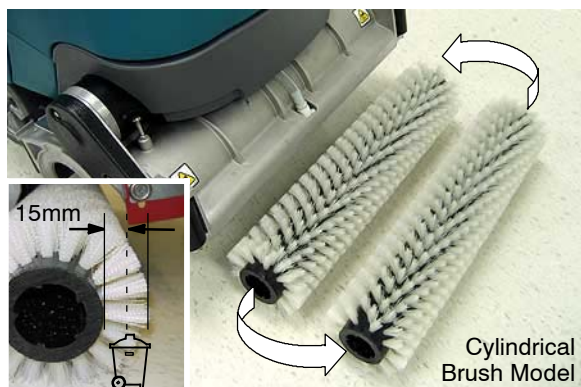

FIG. 73

8. Remove debris buildup from the underside of the cylindrical brush scrub head, including the idler plates and drive hubs (Figure 74).



FIG. 74

9. Wipe the squeegee blades clean (Figure 75). Store the squeegee assembly in the raised position to prevent blade damage.

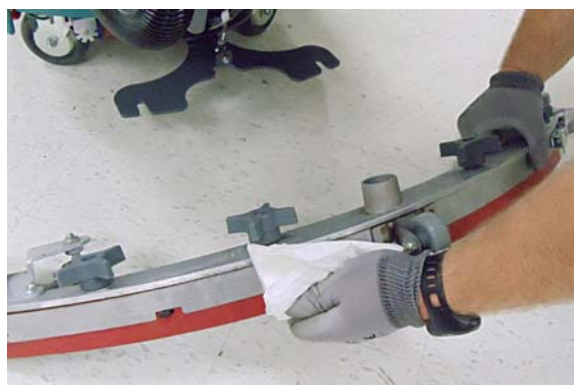

FIG. 75

10. Check the condition of the squeegee blade wiping edge (Figure 76). Rotate blade if worn (See SQUEEGEE BLADES).



FIG. 76

11. Clean the machine with an all purpose cleaner and damp cloth (Figure 77).

FOR SAFETY: When servicing machine, do not power spray or hose off machine.



FIG. 77

12. Inspect the condition of the scrub head skirt, replace if worn or damaged (Figure 78).

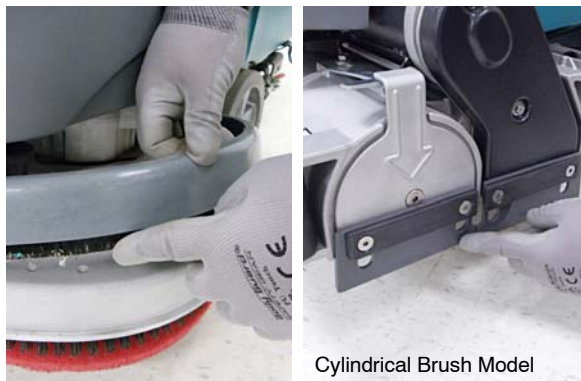

FIG. 78

13. FaST Model: Connect the FaST-PAK supply hose to the storage plug when not in use (Figure 79). Remove any dried concentrate from the hose connector by soaking it in warm water.

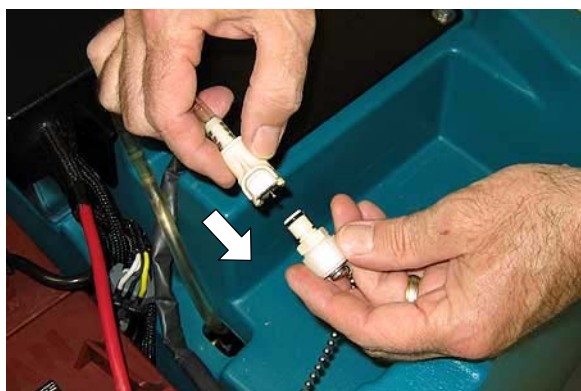

FIG. 79

14. Recharge the batteries (Figure 80). See CHARGING BATTERIES.



FIG. 80

15. Check the battery electrolyte level weekly (See BATTERY MAINTENANCE).
16. Clean wet/lead acid batteries to prevent corrosion and check for loose battery cable connections (See BATTERY MAINTENANCE).

MONTHLY MAINTENANCE

1. Remove the solution tank filter from underneath the machine and rinse out the screen (Figure 81). Make sure the solution tank is empty before removing filter.



FIG. 81

2. Periodically check the belt tension on the two brush motors. Tighten the belt if you're able to twist it beyond 90° at midpoint (Figure 82).

FOR SAFETY: Before leaving or servicing machine, stop on level surface, turn off machine, remove key and set parking brake if equipped.

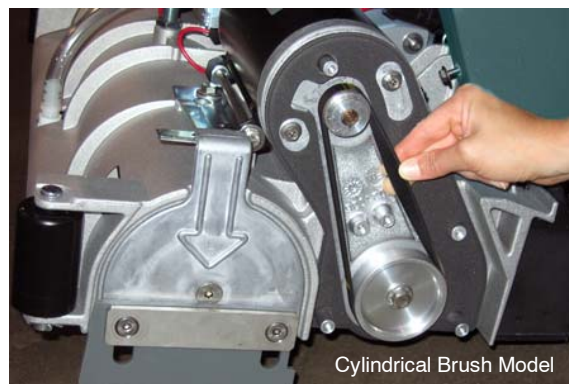

Cylindrical Brush Model

FIG. 82

3. Inspect and clean the recovery tank cover seal (Figure 83). Replace if damaged.



FIG. 83

4. Lubricate all pivot points and rollers with a water resistant grease.
5. Lubricate the casters with a water resistant grease (Figure 84).



FIG. 84

6. Clean the parking brake clamp with a cleaning solvent.
7. Check the machine for loose nuts and bolts.
8. Check the machine for leaks.

OPERATION

BATTERY MAINTENANCE

FOR SAFETY: Before leaving or servicing machine, stop on level surface, turn off machine, remove key and set parking brake if equipped.

FOR SAFETY: When servicing machine, wear personal protection equipment as needed. Avoid contact with battery acid.

MAINTENANCE-FREE BATTERIES

Maintenance-free (Sealed AGM) batteries do not require watering. Cleaning and other routine maintenance is still required.

FLOODED (WET) LEAD-ACID BATTERIES

The flooded (wet) lead-acid batteries require routine watering as described below. Check the battery electrolyte level weekly.

The electrolyte level should be slightly above the battery plates as shown before charging (Figure 85). Add distilled water if low. DO NOT OVERFILL. The electrolyte will expand and may overflow when charging. After charging, distilled water can be added up to about 3 mm (0.12 in) below the sight tubes.



Before Charging

After Charging

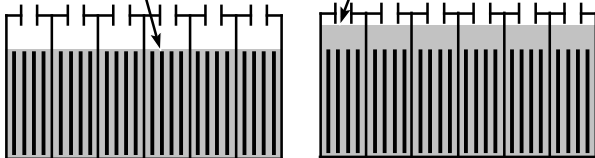

FIG. 85

NOTE: Make sure the battery caps are in place while charging. There may be a sulfur smell after charging batteries. This is normal.

CHECKING CONNECTIONS / CLEANING

After every 200 hours of use, check for loose battery connections and clean the surface of the batteries, including terminals and cable clamps to prevent battery corrosion. Use a scrub brush with a strong mixture of baking soda and water (Figure 86). Do not remove battery caps when cleaning batteries.



FIG. 86

SQUEEGEE BLADES

FOR SAFETY: Before leaving or servicing machine, stop on level surface, turn off machine, remove key and set parking brake if equipped.

When the blades become worn, simply rotate the blades end-for-end or top-to-bottom to a new wiping edge. Replace blades when all edges are worn.

The front blades on the 700mm/800mm squeegee assemblies have 12/14 slots on one edge and 6 slots on the opposite edge (Figure 87). If making sharp turns with the cylindrical brush models use the 12/14 slotted edge for maximum water pickup.

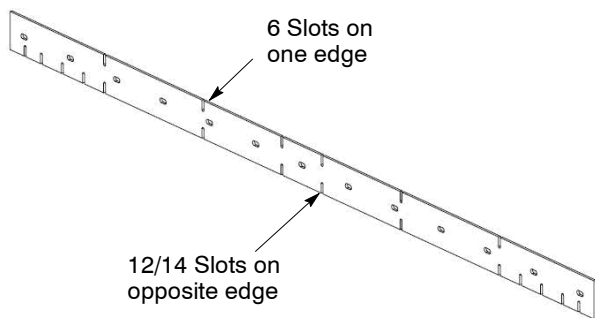

FIG. 87

Replacing Squeegee Blades:

1. Loosen the band clamp and remove the band from the squeegee assembly (Figure 88).

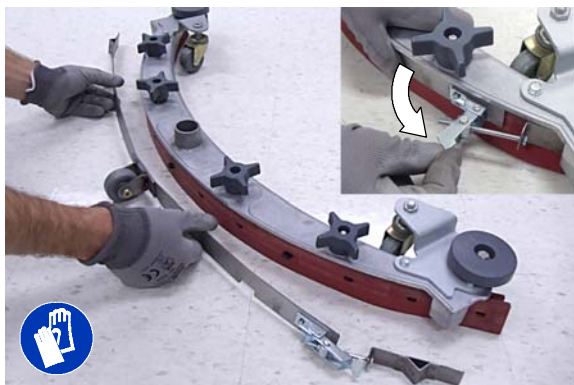

FIG. 88

2. Replace or rotate the rear blade to a new wiping edge and replace band (Figure 89).

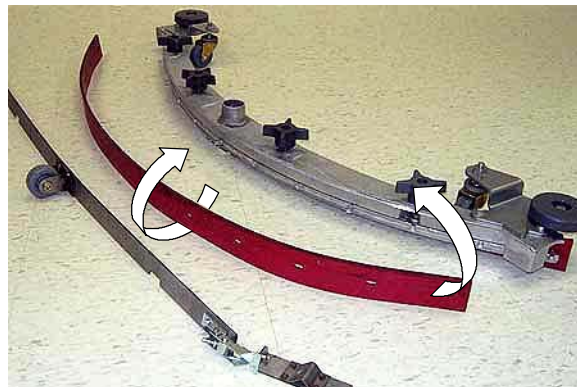

FIG. 89

3. To change the front blade, remove the band and loosen the four knobs. Replace or rotate the front blade to a new wiping edge (Figure 90)

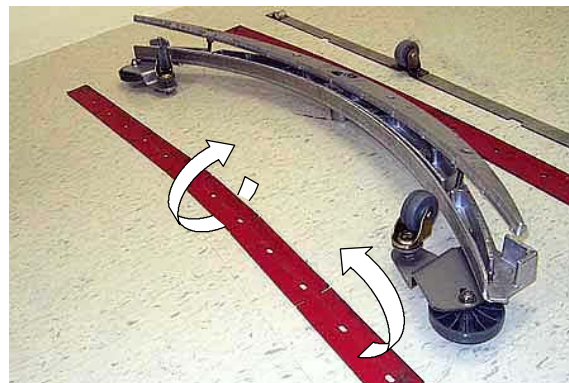

FIG. 90

MOTOR MAINTENANCE

Contact an Authorized Tennant Service Center for carbon brush replacement.

Carbon Brush Replacement	Hours
Drive Transaxle Motor	750
Vacuum Motor	
Disk Brush Motors	
Cylindrical Brush Motors	1000

⚠ WARNING: Electrical Hazard. Disconnect Battery Cables Before Servicing Machine.

OPERATION

FaST SYSTEM MAINTENANCE

Every 1000 hours replace the water filter and air filter located in the FaST detergent injector.

FOR SAFETY: Before leaving or servicing machine, stop on level surface, turn off machine, remove key and set parking brake if equipped.

1. To access the detergent injector assembly, lower the scrub head and remove the front shroud (Figure 91)

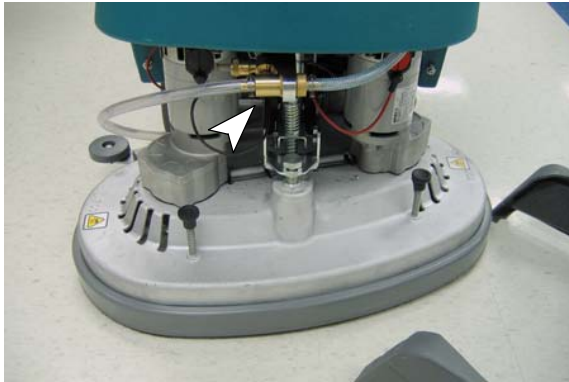

FIG. 91

2. Remove the injector assembly from clamps (Figure 92).

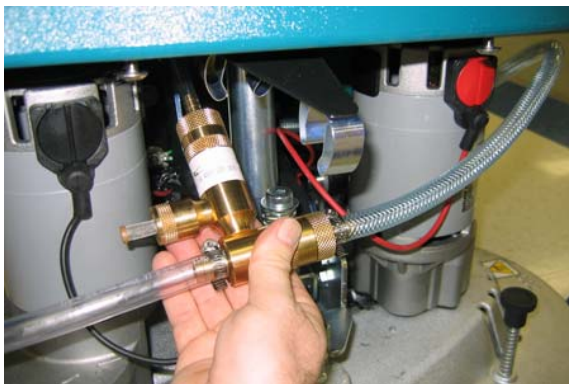

FIG. 92

3. Replace the water and air filter. An 8mm hex wrench required to install new water filter (Figure 93).

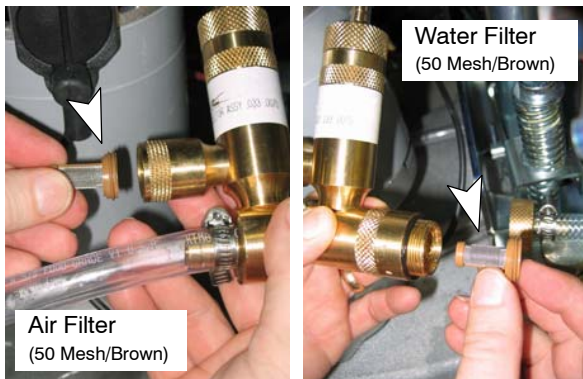

FIG. 93

ec-H2O NanoClean WATER CONDITIONING CARTRIDGE REPLACEMENT

(ec-H2O models labeled ec-H2O NanoClean)

The water conditioning cartridge is required to be replaced when it reaches its maximum water usage or expiration time of when the cartridge was activated, whichever ever comes first. The ec-H2O system indicator light will blink green/red when it's time to replace cartridge.

Depending on machine usage, on average, a new cartridge can last anywhere from 12 months for heavy machine usage to 24 months for light machine usage.

ATTENTION: During first time use and after replacing the water conditioning cartridge, the ec-H2O system will automatically override the selected solution flow rate for up to 75 minutes.

1. Park the machine on a level surface, lower scrub head and remove the key. Set parking brake, if equipped.
2. Remove front shroud to access cartridge. The cartridge is located behind the right side brush motor (Figure 94). Unfasten strap around cartridge and remove cartridge from holder.

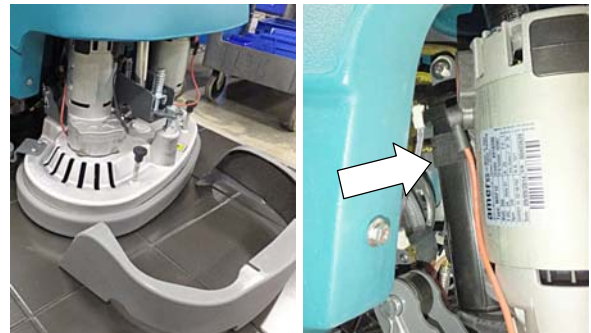

FIG. 94

3. Disconnect the two hose connectors from cartridge by pressing the gray collars inward and pulling the connectors outward (Figure 95).



FIG. 95

- Fill in the installation date on the new cartridge label (Figure 96).



FIG. 96

- Reconnect the two hoses to new cartridge and re-strap cartridge to holder. Make sure the hose connectors are fully inserted into new cartridge.
- Reset timer for new cartridge.

Carefully read and understand all steps first before performing procedure.

- Turn key on.
- Press and hold the service switch, located on the ec-H2O module, for 10 seconds. After releasing service switch, the three solution flow indicator lights will begin to (ripple) move back and forth (Figure 97).
- Within 5 seconds after releasing the service switch, while the three indicator lights are moving back and forth, press and quickly release the solution flow button located on ec-H2O module (Figure 97).

The three indicator lights will then blink three times to indicate timer has been reset.

Repeat process if the three indicator lights do not blink three times.

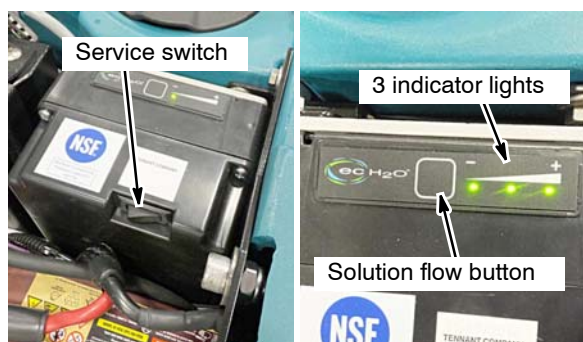

FIG. 97

ec-H2O MODULE FLUSH PROCEDURE

(ec-H2O models manufactured before ec-H2O NanoClean models)

This procedure is only required when an alarm sounds and the ec-H2O system indicator light begins to blink red.

FOR SAFETY: Before leaving or servicing machine, stop on level surface, turn off machine, remove key and set parking brake if equipped.

- Drain the solution tank and recovery tank of all water.
- Pour 1 gallon (4 liters) of white or rice vinegar into the solution tank at full strength. Do not dilute.

NOTE: Use white or rice vinegar only. The acidity level should be between 4-8%. Do not use other acids for this procedure.

- Disconnect the black connector fitting at the scrub head and place the hose into a bucket (Figure 98). To access the connector fitting, you may have to remove the front cover from the machine.

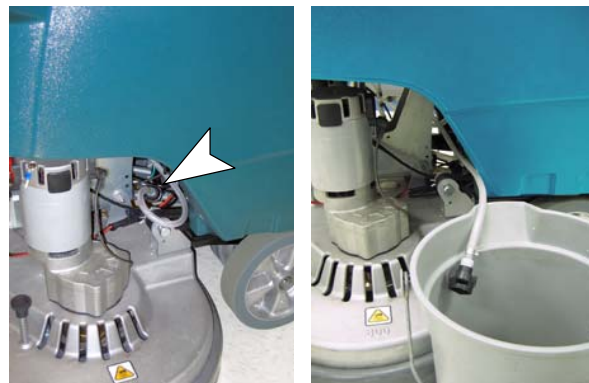

FIG. 98

- Turn the key to the on (I) position.

OPERATION

5. Press and release the ec-H2O module flush switch to start the flush cycle (Figure 99). The module is located under the recover tank.

NOTE: The module will automatically shut off when the flush cycle is complete (approx. 7 minutes). The module must run the full 7 minute cycle in order to reset the system indicator light and alarm.

Repeat flush procedure if the ec-H2O module does not reset. If module fails to reset, contact an Authorized Service Center.

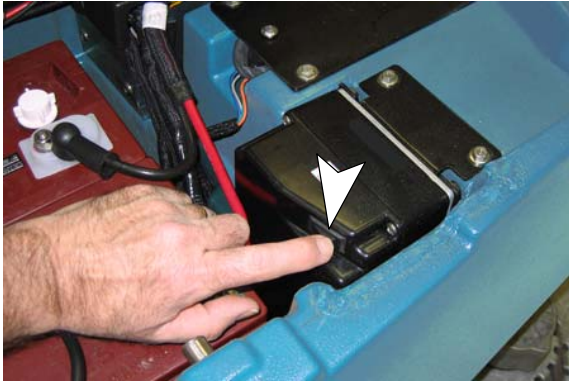

FIG. 99

JACKING UP MACHINE

Use the designated locations to jack up the machine for service (Figure 100). Empty the recovery and solution tank and position the machine on a level before jacking.

FOR SAFETY: When servicing machine, jack machine up at designated locations only. Use jack or hoist that will support machine weight.

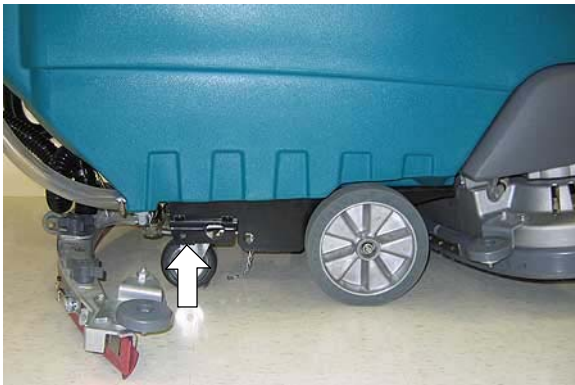

FIG. 100

TRANSPORTING MACHINE

When transporting the machine by trailer or truck, be certain to follow the transporting procedure below:

1. Drain machine tanks.
2. Load the machine using a ramp that can support the machine weight and person loading it. The maximum ramp incline should not exceed 19.5% at a ramp length of 12 ft (3.7m).

FOR SAFETY: When loading/unloading machine onto/off truck or trailer, use a ramp, truck or trailer that will support the weight of the machine and operator. Use tie-down straps to secure machine to truck or trailer.

3. Position the front of machine up against the front of the trailer or truck. Lower the scrub head and squeegee.
4. Set the parking brake, if equipped, and place a block behind each wheel to prevent the machine from rolling.
5. Secure with tie-down straps as shown (Figure 101). It may be necessary to install tie-down brackets to trailer or truck.

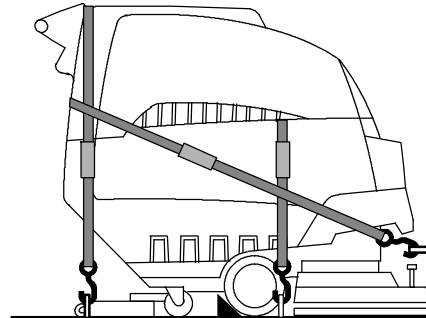

FIG. 101

STORING MACHINE

1. Charge the batteries before storing machine to prolong the life of the batteries. Recharge batteries once a month.
2. Disconnect batteries before storing.
3. Drain and rinse the tanks thoroughly.
4. Store the machine in a dry area with the squeegee and scrub head in the up position.
5. Open the recovery tank cover to promote air circulation.

ATTENTION: Do not expose machine to rain, store indoors.

6. If storing machine in freezing temperatures, follow the FREEZE PROTECTION instructions below.

FREEZE PROTECTION

FOR SAFETY: Before leaving or servicing machine, stop on level surface, turn off machine, remove key and set parking brake if equipped.

1. Drain the solution tank and recovery tank of all water.
2. Empty the solution tank filter located under the machine (Figure 102).



FIG. 102

3. Pour 1 gallon (4 liters) of recreational vehicle (RV) antifreeze into the solution tank at full strength. Do not dilute.
4. Turn the machine power on and operate the solution flow system. Turn the machine off when the red RV antifreeze is visible.

If your machine is equipped with the off-aisle wand option, operate the off-aisle wand for a few seconds to protect the pump.

Continue with the freeze protection procedure if machine is equipped with the FaST or *ec-H2O* system.

ec-H2O NanoClean Models:

(ec-H2O models labeled ec-H2O NanoClean)

Operate machine in the *ec-H2O* mode to cycle antifreeze through *ec-H2O* system.

After storing machine in freezing temperatures, drain any remaining antifreeze from the solution tank. Add clean water to solution tank and operate the machine to flush system.

ec-H2O Models:

(ec-H2O models manufactured before ec-H2O NanoClean models)

Press and release the flush switch on the *ec-H2O* module to cycle the antifreeze through *ec-H2O* system (Figure 103). When the antifreeze is visible, press the switch again to turn off the module.

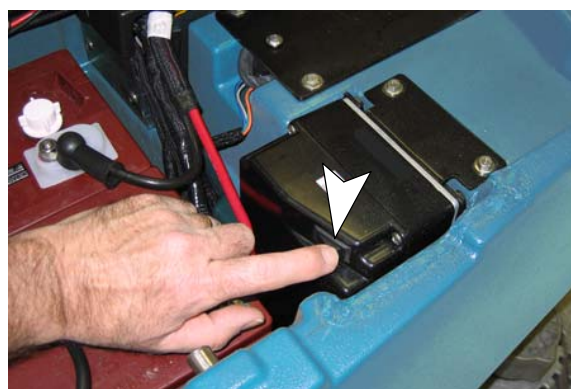

FIG. 103

IMPORTANT: Before operating machine, the antifreeze must be flushed from the module as described below.

If the antifreeze is not properly flushed from the *ec-H2O* system, the *ec-H2O* module may detect an error and not function (*ec-H2O* switch indicator light will turn red). If this occurs, reset key and repeat the flush procedure as described below.

Flushing antifreeze from ec-H2O module:

(ec-H2O models manufactured before ec-H2O NanoClean models)

1. Drain the antifreeze from the solution tank into a bucket.
2. Fill the solution tank with cool water until full (See FILLING SOLUTION TANK).
3. Disconnect the black connector fitting at the scrub head and place the hose into a bucket (Figure 104). To access the connector fitting, you may have to remove the front cover from the machine.

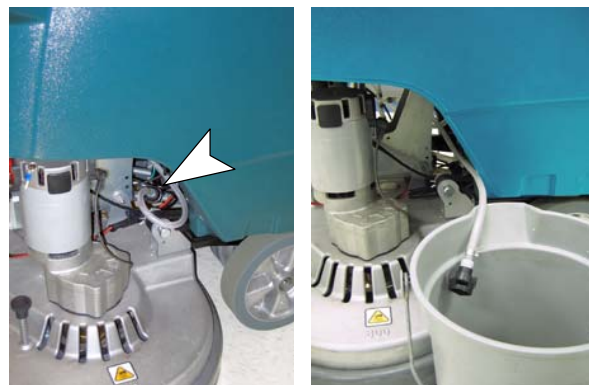

FIG. 104

4. Press and release the *ec-H2O* module switch to flush the antifreeze from the *ec-H2O* system (Figure 103). The module is located under the recovery tank.

When the water turns clear, press the module switch again to stop the flush cycle.

Dispose the antifreeze in an environmentally safe way according to local waste disposal regulations.

5. The machine is now ready for scrubbing.

OPERATION

FaST Model:

The following items are required: valve coupling #1002856 and 6 in (15 cm) hose #63182.

1. Remove the FaST-PAK carton and connect the valve coupling and 6 in (15 cm) hose to the FaST detergent supply hose (Figure 105).

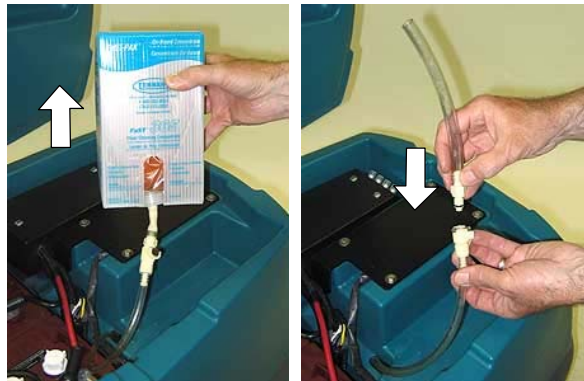

FIG. 105

2. Disconnect the opposite end of the FaST supply hose from the injector assembly and drain the detergent from the hose (Figure 106). Reconnect the hose after draining. To access the injector assembly remove the front cover.



FIG. 106

3. Pour the recreational vehicle (RV) antifreeze into the supply hose until full (Figure 107).

4. Keep the hose upright to prevent the antifreeze from spilling and lower the recovery tank.



FIG. 107

5. Operate the FaST system until the foaming stops. This step could take anywhere from 5 to 10 minutes.
6. When finished, connect the supply hose to the storage plug (Figure 108).

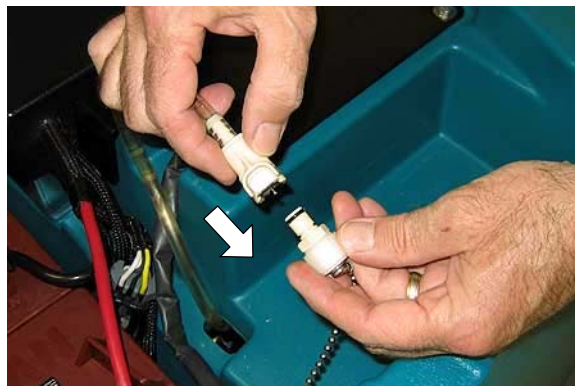

FIG. 108

7. To drain the antifreeze from the FaST supply hose, repeat steps 1 and 2.

Dispose of the antifreeze in an environmentally safe way according to local waste disposal regulations.

TROUBLESHOOTING

PROBLEM	CAUSE	SOLUTION
Machine will not operate	Discharged batteries	Charge batteries
	Emergency- stop button activated	Turn button clockwise to reset
	Faulty battery(s)	Replace battery(s)
	Loose battery cable	Tighten loose cable
	Tripped main circuit breaker	Reset 10A main circuit breaker
	Main fuse blown	Replace 100A main fuse
	Faulty key switch	Contact Service Center
	Machine fault detected.	See Battery Meter LED Fault Codes
On- board battery charger will not operate	Plug not connected to power supply	Check plug connection
	Faulty charger fuse	Replace charger fuse
	Faulty power supply cord	Replace cord
	Error detected.	See On- board Battery Charger Error Codes
Brush motor(s) will not operate	Scrub head is raised off floor	Lower scrub head
	Battery meter lockout activated	Recharge batteries
	Discharged batteries	Charge batteries
	Tripped brush motor circuit breaker	Reset 25A circuit breaker button
	Faulty scrub head (up/down) switch	Contact Service Center
	Faulty trigger switch(es)	Contact Service Center
	Faulty brush motor or wiring	Contact Service Center
	Worn carbon brushes	Contact Service Center
	Broken or loose belt (cylindrical brush model)	Replace or tighten belt
	Faulty relay switch	Contact Service Center
Machine will not propel	Parking brake is set	Release parking brake lever
	Machine fault detected	See Battery Meter LED Fault Codes
	Propel motor fuse blown	Replace 30A fuse
	Faulty transaxle motor or wiring	Contact Service Center
	Worn carbon brushes	Contact Service Center
	Exceeded maximum incline	Avoid steep inclines and reset key
Vacuum motor will not operate	Squeegee is raised off floor	Lower squeegee
	Discharged batteries	Charge batteries
	Tripped vacuum motor circuit breaker	Reset 25A circuit breaker button
	Faulty vacuum motor or wiring	Contact Service Center
	Worn carbon brushes	Contact Service Center
Little or no solution flow	Solution tank is empty	Fill solution tank
	Clogged solution tank filter	Clean solution tank filter
	Discharged batteries	Charge batteries
	Clogged solution valve	Remove valve and clean
	Solution flow control knob set too low	Adjust solution control flow knob
	Loose screw on control knob	Calibrate knob and retighten screw.

OPERATION

TROUBLESHOOTING - Continued

PROBLEM	CAUSE	SOLUTION
Poor water pickup	Recovery tank is full or excessive foam buildup	Drain recovery tank
	Loose drain hose cap	Tighten cap
	Clogged float shut-off screen located in recovery tank	Clean screen
	Clogged squeegee assembly	Clean squeegee assembly
	Worn squeegee blades	Replace or rotate squeegee blades
	Incorrect Squeegee blade deflection	Adjust Squeegee blade height
	Loose vacuum hose connections	Secure hose connections
	Clogged vacuum hose	Remove clogged debris
	Damaged vacuum hose	Replace vacuum hose
	Recovery tank cover not in place	Properly position cover
	Damaged recovery tank cover seal	Replace seal
	Faulty vacuum motor	Contact Service Center
	Low battery charge	Recharge batteries
Poor scrubbing performance	Debris caught in brush	Remove debris
	Worn brushes/pads	Replace brushes/pads
	Incorrect brush pressure setting	Adjust pressure setting
	Wrong brush/pad type.	Use correct brush/pad
Reduced run time	Batteries not fully charged	Fully recharge batteries
	Defective batteries	Replace battery
	Batteries need maintenance	See BATTERY MAINTENANCE
	Faulty battery charger	Repair or replace battery charger
FaST Model: FaST System does not operate or operate correctly	FaST system switch is not turned on	Turn on FaST system switch
	FaST-PAK supply hose not connected	Connect supply hose
	Clogged FaST-PAK supply hose or connectors	Soak in warm water to unclog
	Empty FaST-PAK carton	Replace FaST-PAK carton
	Kink in FaST-PAK supply hose	Undo hose kink
	Clogged FaST solution system	Contact Service Center
	Faulty FaST system on/off switch	Contact Service Center
	Faulty pump	Contact Service Center
	Clogged solution tank filter	Drain solution tank. Remove solution tank filter, clean and reinstall
	Clogged detergent orifice/filter screen	Replace orifice/filter screen (See FaST SYSTEM MAINTENANCE)
	Clogged FaST solution inlet filter	Contact Service Center
FaST Pump fuse blown	Replace 7.5A fuse	

TROUBLESHOOTING - Continued**ec-H2O NanoClean Models (ec-H2O models labeled ec-H2O NanoClean)**

PROBLEM	CAUSE	SOLUTION
ec-H2O system indicator light blinking green/red	Water conditioning cartridge has expired	Replace cartridge (See ec-H2O NanoClean WATER CONDITIONING CARTRIDGE REPLACEMENT)
ec-H2O system indicator light is red or blinking* red	ec-H2O system fault has been detected	Contact Service Center

*Verify if cleaning detergent was added to solution tank. If ec-H2O system was operated with cleaning detergent, drain solution tank, add clear water and operate the ec-H2O system until the indicator light code clears.

ec-H2O Models (ec-H2O models manufactured before ec-H2O NanoClean models)

PROBLEM	CAUSE	SOLUTION
ec-H2O system indicator light blinking red	Mineral deposit build-up in module	Flush module (See ec-H2O MODULE FLUSH PROCEDURE)
Alarm sounds		
ec-H2O system indicator light solid red	The freeze protection antifreeze was not removed prior to using machine	Flush antifreeze from module. See FIRST TIME USE for flushing instructions.
	Defective module	Contact Service Center
ec-H2O system indicator light does not turn on	Defective light or module	Contact Service Center
No water flow	Clogged module	Contact Service Center
	Defective solution pump	Contact Service Center

BATTERY METER LED FAULT CODES

CODE (Flashing LED Bars)	FAULT	SOLUTION
One	Low voltage shut-off.	Recharge batteries.
	Scrubbing function stops.	Check battery connection.
Two	Battery charge level getting low.	Recharge batteries.
Three	Drive motor tripped.	Remove overload condition and reset key.
	Short circuit to drive motor.	Contact Service Center.
Four	Battery lockout.	Recharge batteries immediately.
Eight	Controller tripped.	Contact Service Center.
Ten	High battery voltage reading.	Check battery connections.
No Bars	Sleep mode.	Turn key to restore.
Bars Rippling	Throttle engaged at start up.	Release triggers.

OPERATION

MACHINE SPECIFICATIONS

MODEL	Disk, 600mm	Disk, 700mm	Disk, 800mm	Cylindrical, 650mm	Cylindrical, 800mm
LENGTH	1,357 mm	1,408 mm	1,471 mm	1,399 mm	1,399 mm
WIDTH	645 mm	737 mm	838 mm	711 mm	864 mm
HEIGHT	1,120 mm				
MINIMUM AISLE TURN	1,346 mm	1,499 mm	1,626 mm	1,575 mm	1,638 mm
WEIGHT	133 kg	145 kg	151 kg	151 kg	155 kg
WEIGHT WITH BATTERIES	258 kg	269 kg	275 kg	275 kg	279 kg
RECOVERY TANK CAPACITY	105 L				
SOLUTION TANK CAPACITY	85 L				
DRIVE SYSTEM	Transaxle, 24 V, .19 kW				
TRAVEL SPEED, MAXIMUM	Cleaning: 67 m/min Transporting: 72 m/min				
PRODUCTIVITY RATE Theoretical	2,450 m ² /hr	2,860 m ² /hr	3,270 m ² /hr	2,660 m ² /hr	3,270 m ² /hr
PRODUCTIVITY RATE Estimated Actual	1,660 m ² /hr	1,930 m ² /hr	2,230 m ² /hr	1,785 m ² /hr	2,230 m ² /hr
CLEANING PATH WIDTH	600 mm	700 mm	800 mm	650 mm	800 mm
BRUSH DIAMETER	302 mm	353 mm	404 mm	151 mm	151 mm
BRUSH PRESSURE	Up to 54 kg				
SOLUTION FLOW RATE	1.89 L /min	1.89 L/min		2.27 L/min	2.27 L/min
SQUEEGEE WIDTH	908 mm standard	1,051 mm standard	1,185 mm standard	1,051 mm standard	1,185 mm standard
	800 mm narrow aisle	908 mm narrow aisle	1,051 mm narrow aisle	908 mm narrow aisle	1,051 mm narrow aisle
BRUSH MOTOR	Qty 2, .55 kW, 220rpm, 24 V, 29 A			Qty 2, .47 kW, 1500 rpm, 24 V, 23 A	
VACUUM MOTOR	640 W, 3- stage 5.7, 24 V, 26 A				
WATER LIFT/AIR FLOW	55 mm H ₂ O/ 32.4 L ³ /m				
BATTERIES	Qty 4, 6 V				
BATTERY CAPACITY	WET (lead Acid) = 235Ah @ 20 h rate Sealed (Gel)= 200Ah @ 20 h rate				
RUN TIME PER CHARGE*	WET = Up to 5.0 hours Gel = Up to 4.0 hours				
ON- BOARD CHARGER	120VAC, 10A, 50/60Hz, 24VDC, 20A output / 230VAC, 5A, 50/60Hz, 24VDC, 20A output				
TOTAL POWER CONSUMPTION	50 A nominal				
VOLTAGE DC	24 VDC				
PROTECTION GRADE	IPX3				
DECIBEL RATING AT OPERATOR'S EAR, INDOORS.**	67dBA			68dBA	
VIBRATION AT CONTROLS	<.1188 m/s ²			<.103 m/s ²	
ACCELERATION RATE ON OPERATOR - MAX.	.179 m /s ²				
GRADE LEVEL, MAX.	Scrubbing 5%, Transporting 8%, Ramp Loading 19.5%				

* Run times are based on Continuous Scrubbing Run Times.

** Sound levels (ISO 11201) as recommended by the American Association of Cleaning Equipment Manufacturers (AACEM) and OSHA.

FaST SYSTEM	Disk, 600mm	Disk, 700mm	Disk, 800mm	Cylindrical, 650mm	Cylindrical, 800mm
PRODUCTIVITY RATE Estimated Actual	1865 m ² /hr	2115 m ² /hr	2440 m ² /hr	1950 m ² /hr	2440 m ² /hr
SOLUTION PUMP	24 Volt DC, 3.5 A, 5.6 L/min open flow, 4.13 Bar bypass setting				
SOLUTION FLOW RATE	0.57 L/min.	0.83 L/min.		0.57 L/min.	0.83 L/min.
CONCENTRATE FLOW RATE	0.57 CC/min.	0.83 CC/min.		0.57 CC/min.	0.83 CC/min.
CONCENTRATE TO WATER DILUTION RATIO	1:1000				
<hr/>					
ec-H2O SYSTEM	Disk, 600mm	Disk, 700mm	Disk, 800mm	Cylindrical, 650mm	Cylindrical, 800mm
PRODUCTIVITY RATE Estimated Actual	1865 m ² /hr	2115 m ² /hr	2440 m ² /hr	1950 m ² /hr	2440 m ² /hr
SOLUTION PUMP	24 Volt DC, 3.5 A, 5.6 L/min open flow, 4.13 Bar bypass setting				
SOLUTION FLOW RATE*	0.57 L/min. (standard)	0.83 L/min. (standard)		0.83 L/min. (standard)	1.25 L/min. (standard)
	0.83 L/min. (optional)	1.25 L/min. (optional)		1.14 L/min. (optional)	1.67 L/min. (optional)
	1.14 L/min. (optional)	1.67 L/min. (optional)			

* ec-H2O models manufactured before ec-H2O NanoClean Models - If the optional solution flow rates are required, contact an Authorized Service Center.

MACHINE DIMENSIONS

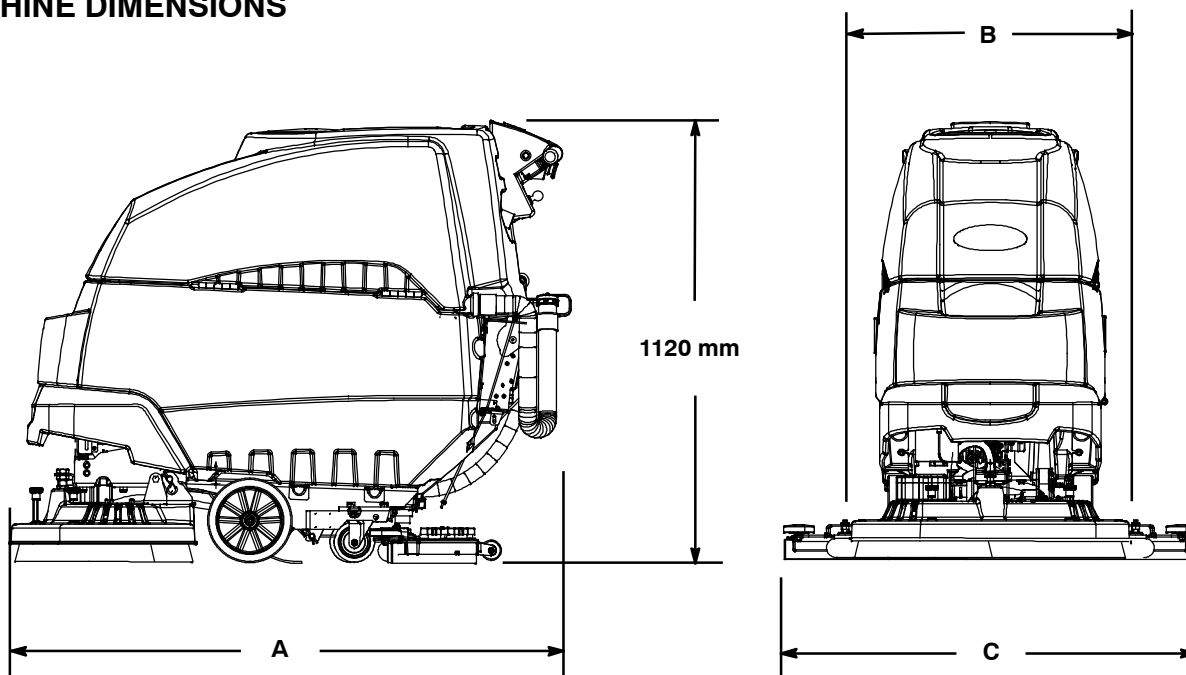

Models:	600 mm Disk	700 mm Disk	800 mm Disk	650 mm Cylindrical	800 mm Cylindrical
A =	1,357 mm	1,408 mm	1,471 mm	1,399 mm	1,399 mm
B =	645 mm	737 mm	838 mm	711 mm	864 mm
C =	908 mm	1,051 mm	1,185 mm	1,051 mm	1,185 mm